



Semiconductor Backend Tools Catalog



2022



AT A GLANCE

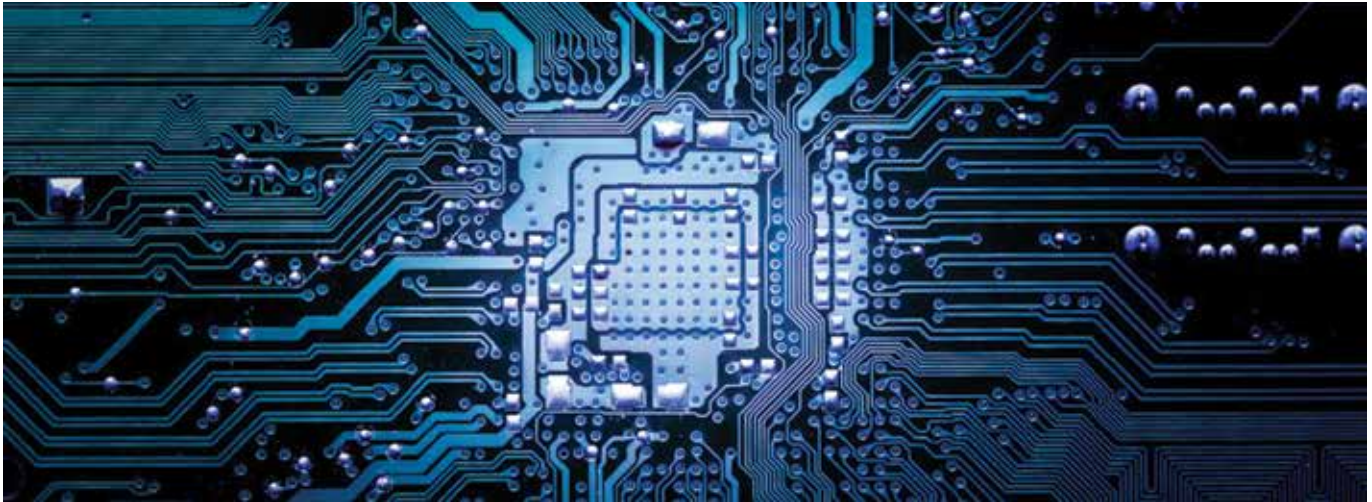

Oricus Semicon Solutions is an innovative Semiconductor Tools manufacturing company who, with almost 100 years of collective expertise, craft high tech bespoke tooling solutions for the global Semiconductor Assembly and Test industry.

From one-off customised products to large scale production, our R&D strength, precision manufacturing experience and problem-solving capabilities are impeccable. With a passion for engineering and customer oriented service, we deliver price competitive precision Semiconductor Tooling solutions to a global market with a local presence.

Oricus is made up of a global network of professionals with strong commitment and passion for our work. The company is managed and operated with a spirit of professionalism based on the foundation of integrity, equality and respect. We are determined, objective with a sense of ownership to deliver on our goals. We value our values, professionalism, passion, perseverance and our relentless pursuit to deliver value for our customers.



Authenticity



Expertise



Professionalism



Perseverance



Passion



Community

Oriented to Customer's needs



We excel at creating specials – one of a kind pieces, with one of a kind craftsmanship combining with the latest in manufacturing technology to produce micro precision tooling. Oricus can Design and Manufacture either one-offs or high volume orders to your unique specifications, from High Temperature resistant tools for Power Devices to tools with complex geometries for 3D Advanced Packaging.

Industry Leading Solutions

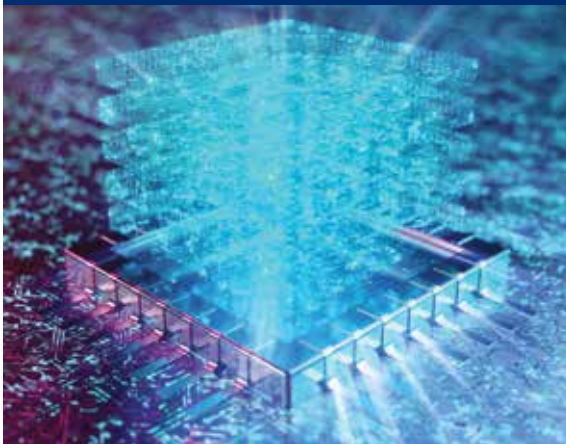

Our Technical Sales Consultants and R&D teams of seasoned Semiconductor Assembly and Test industry professionals will study your chip and package requirements and offer effective and competitive tooling solutions that will work right out of the box. Oricus has the solution to your tooling requirements. Leave it to us and you can focus on your key processes.

Research and Development



R&D is the cornerstone of our commitment to deliver market leading tooling solutions. Our Material Science know-how, coupled with our Manufacturing Expertise and knowledge on the latest demands of Integrated Circuits Packaging allow us to offer tools that maximizes productivity and minimizes downtime.

Die Attach

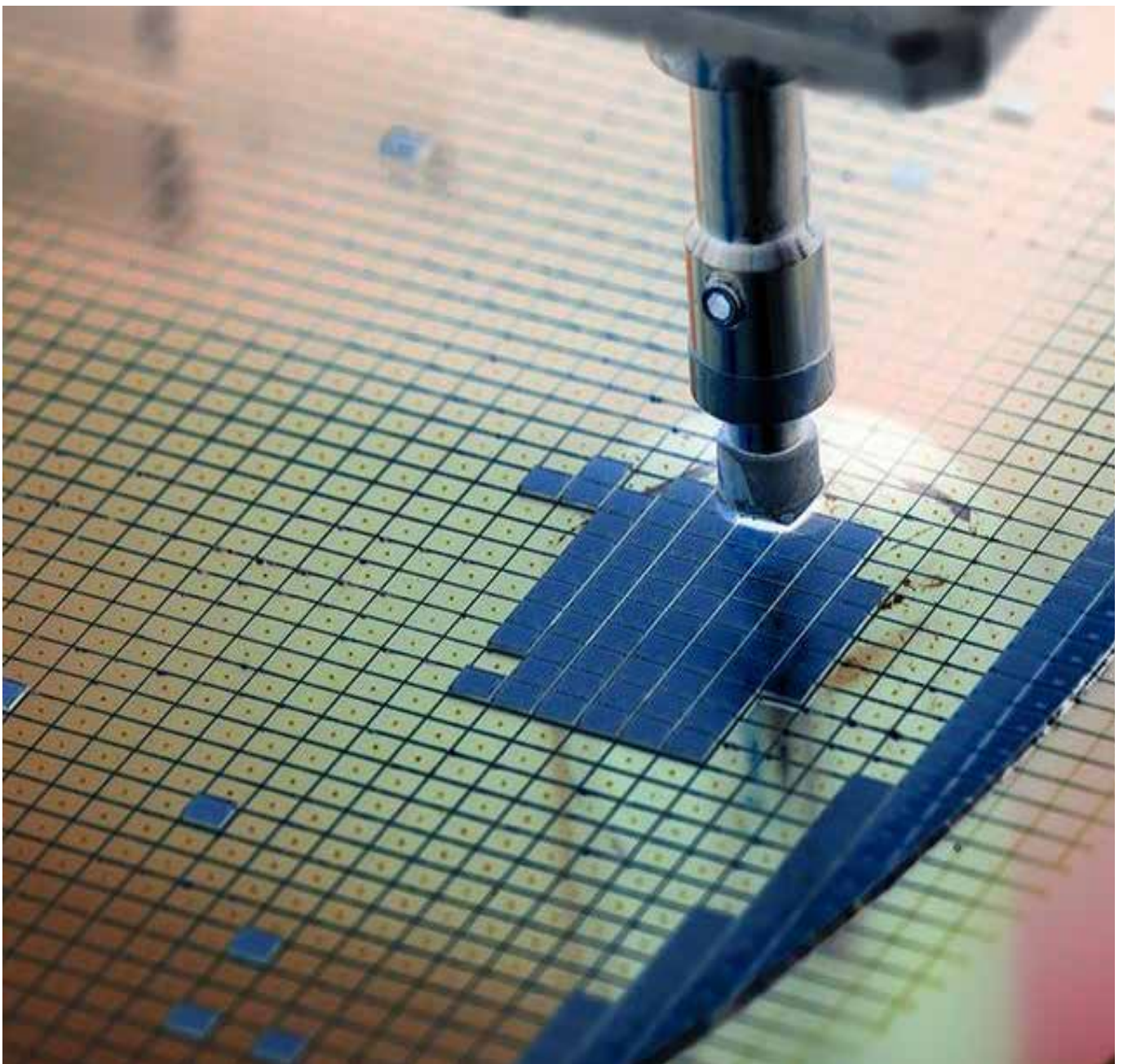

Ejection Systems

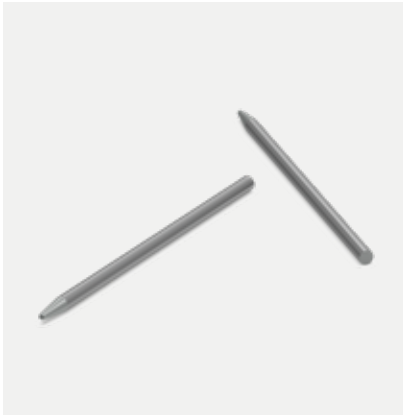

Standard Needles

Features tip designs in Flat Tip and Spherical Radius configurations. Used for Standard die ejection applications.



Twin Needles

Manufactured with Twin ejector tips of a common datum for optimal flatness during the die ejection process.



Quad Needles

Precision machined with a single datum for all 4 tips for Best-in-Class stability and performance of the ejection process.



Needle Holders

Needle Holder layout and positions designed based on your specific application requirements for optimal die ejection results.



Pepper Pots

Our Pepper Pots are designed with carefully considered layout and vacuum holes to ensure superior downwards vacuum suction force.

Part Numbers And Ordering

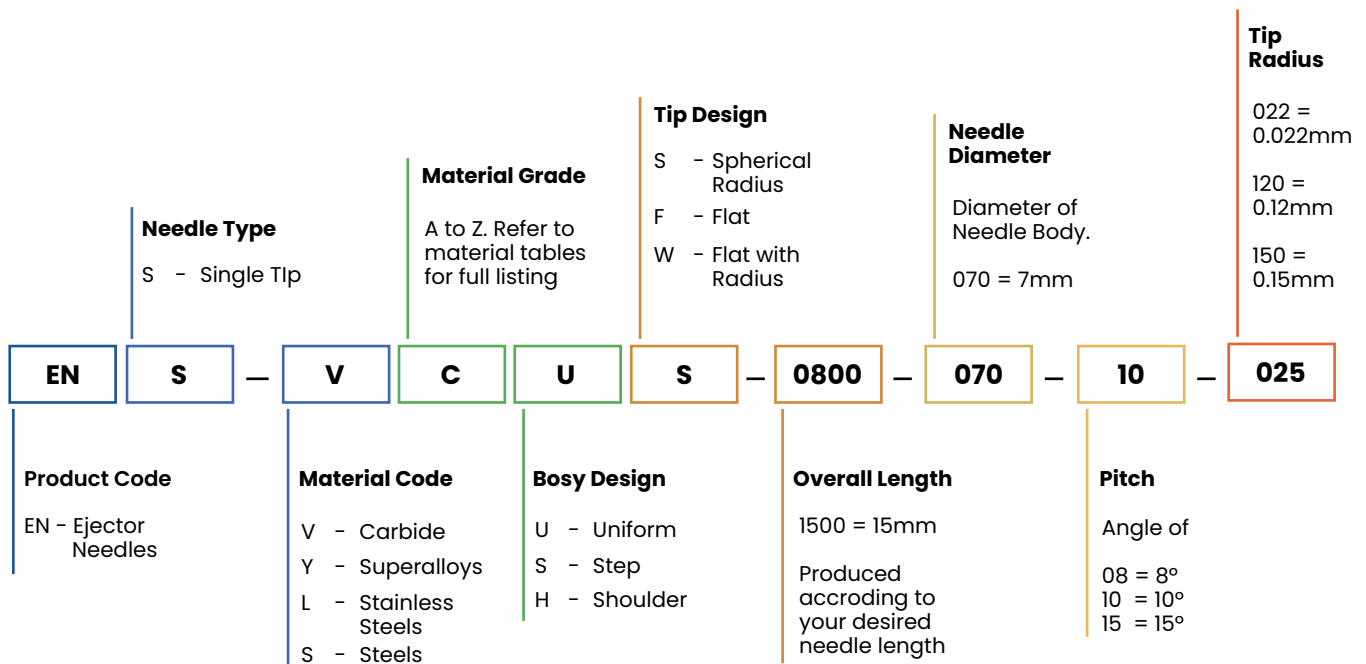

Needle Holder



Needle Holders are a critical interface component between the machine and the rest of the components of a die ejection system. Typically, Needle Holders are used in combination with Ejector Needles and Pepper Pots.

The layout and design of the needle positions on the Needle Holder are of paramount importance to the implementation of a successful die or device ejection process and operation. The overall Needle Holder design concept will be largely dependent on the die or device attributes. Our years of accumulated experience in the design of Die Ejection systems allow us to provide you with highly productive and fuss free Needle Holders.

Oricus manufactures a wide range of Needle Holders and Pepper Pots to fit a wide range of machines from OEMs such as Datacon, ESEC, ASM, Canon Bestem, Hitachi/Fasford, MRSI and more. Needle Holders are available in Spring Loaded, Side Fastening, Press Fit or Adhesive configurations, fully customizable to your process requirements.

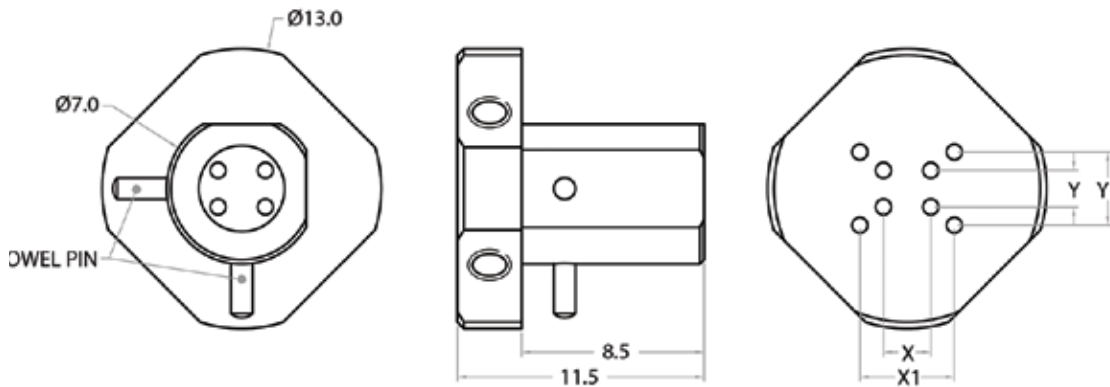

Features

- Suitable for use in Die Bonders, Flip-Chip Die Sorters and Surface Mount Technology (SMT) machines.
- Available in various Stainless Steel and Aluminum grades that are suitable for Cleanroom environments.
- Needle holes made machined to exacting tolerances of perpendicularity, concentricity with minimum hole to hole offset
- A single Needle Holder can be designed and customized to fit a wide range of different die sizes

Benefits

- Our Needle Holders Tool Shanks are manufactured to perfectly into your machine's tool holders
- Plug-and-Play convenience of Ejector Needles into our Needle Holders
- Oricus's Die Ejection Systems consisting of Needle Holders, Ejector Needles and Pepper Pots offer high yield, high productivity with minimum downtime

Part Number	X (mm)	X1 (mm)	Y (mm)	Y1 (mm)
ESN-FBNS-DA03-001	2.20	-	1.70	-
ESN-FBNS-DA03-004	1.50	1.50	3.00	3.00
ESN-FBNS-DA03-005	2.00	2.00	4.00	4.00
ESN-FBNS-DA03-006	2.50	2.50	5.00	5.00



ESD Properties

Conductive < 10⁵ Ω

Applications

Standard Die Attach
Flip Chip
2.5D/3D
Wafer Level Packaging
Panel Level Packaging
System in a Package

Needle Holder Material

Tool Steel
Stainless Steel

Configuration

Spring Loaded
Side Fastening
Press Fit
Adhesive

MATERIALS

Oricus's extensive line of engineered materials specially developed and selected to offer optimal tooling performance for your specific Semiconductor Backend process. Our in-house materials are closely developed in partnership with Original Equipment Manufacturers with input from our customers. For externally procured materials, each material goes through a rigorous Quality Assurance and Performance Assessment programme before making it into our material list.

Oricus' in depth understanding and experience of materials allows us to formulate tooling solutions that work for you. As part of our value proposition, we study the conditions of your application and suggest the most appropriate material that meets your needs.

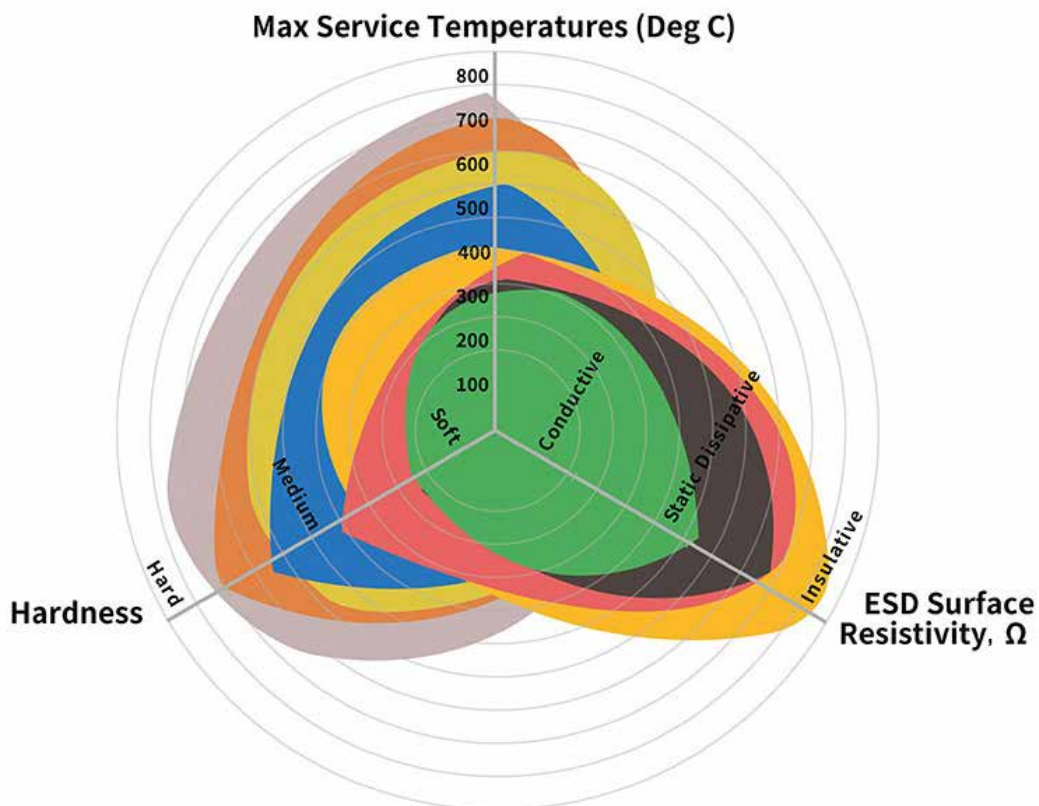

Tungsten Carbide WC Line

Non Ferrous Metals NF Line

Superalloy SA Line

Performance Engineering Plastics SP Line

Stainless Steel SS Line

Engineering Plastics EP Line

Tool Steel TS Line

Rubber R Line

<p>WC LINE</p> <p>Tungsten Carbide</p> <p>High Wear & High Temp Resistance</p> <p>Carbide, K15 Carbide, K30 Carbide, M30 Carbide K40 Carbide, MG30</p>	<p>SA LINE</p> <p>Superalloy</p> <p>All-Round Superior Performance</p> <p>Haynes 25 (L605) Inconel Alloy 625 Inconel Alloy 718 Incoloy Alloy 925 Nitronic 50 Nitronic 60 Titanium Grade 2 Stellite 6 Stellite 31</p>	<p>SS LINE</p> <p>Stainless Steel</p> <p>Balanced Properties</p> <p>15-5 PH 17-4PH SUS 430F SUS 420 SUS 440C SUS 316 SUS 301 SUS 304 SUS 303</p>	<p>TS LINE</p> <p>Tool Steel</p> <p>High Strength</p> <p>CPM-10V SKD 11 SKH 51 Mirrax 40 ASP 23 Stavax XW 10 XW 42 Assab 718 - HH HSS DF2 DF3 Ramax HH Rochling 2315</p>
<p>NF LINE</p> <p>Non Ferrous Metals</p> <p>Special Applications</p> <p>Aluminium 7075 Aluminium 6061 Copper Brass Hovadur K350</p>	<p>SP LINE</p> <p>Performance Engineering Plastics</p> <p>Advantageous Performance & Value</p> <p>Torlon 4432 (PAI) Torlon 4301 (PAI) Torlon 5030 (PAI) Toriion 7130 (PAI) Vespel SCP5050 (P) Vespel SP 21 (PD) Vespel SP1 (PI) ESD Semitron 520 ESD Semitron 420 ESD Semitron 410C ESD Semitron 225</p>	<p>EP LINE</p> <p>Engineering Plastics</p> <p>Economical And Versatile</p> <p>Acrylic/ Polycarbonate TECAFORM SD Delrin ESD Delrin White Delrin Black POM PEEK PEEK HT PEEK GF 30% PEEK CF 30%</p>	<p>R LINE</p> <p>Rubber</p> <p>Geometric Flexibility ESD Protection</p> <p>NBR NBR (Soft) NBR (Hard) NBR (Coated) HPR HPR (Soft) HPR (Hard) UPR CR (ESD) CR</p>

Contact Us

United States

📍 40 Trolley Square, Wilmington, Delaware

✉ us.sales@oricus-semicon.com

☎ +1 302 725 3188

United Kingdom

📍 15 Charleville Circus, Flat 3 London

✉ eu.sales@oricus-semicon.com

☎ +44 330 128 9181

Singapore

📍 2, 488 Sims Avenue, Singapore, 387560

✉ sg.sales@oricus-semicon.com

☎ +65 68649617

Malaysia

📍 8, Jalan Damanlela, Pusat Bandar Damansara Wilayah Persekutuan, Kuala Lumpur

✉ my.sales@oricus-semicon.com

☎ +60 154 600 0140

Philippines

📍 I Light Industry and Science Park of the Philippines Cabuyao, Laguna

✉ ph.sales@oricus-semicon.com

☎ +63 2 8271 2168

China

📍 Block D, Hangcheng Smart Security Science Park Shenzhen Guangdong

✉ cn.sales@oricus-semicon.com

☎ +86 400 842 7789

Hong Kong

📍 #28-34, 88 Commercial Building Wing Lok St Sheung Wang

✉ hk.sales@oricus-semicon.com

☎ +852 3008 8283

Taiwan

📍 7F, No.2-1, WhenHu Street Taipei, 11445

✉ tw.sales@oricus-semicon.com

☎ +886 2 7753 5371

Korea

📍 27 Noksapyeong-daero 26ga-gil Seoul Seoul

✉ kr.sales@oricus-semicon.com

☎ +82 2 2023 6568



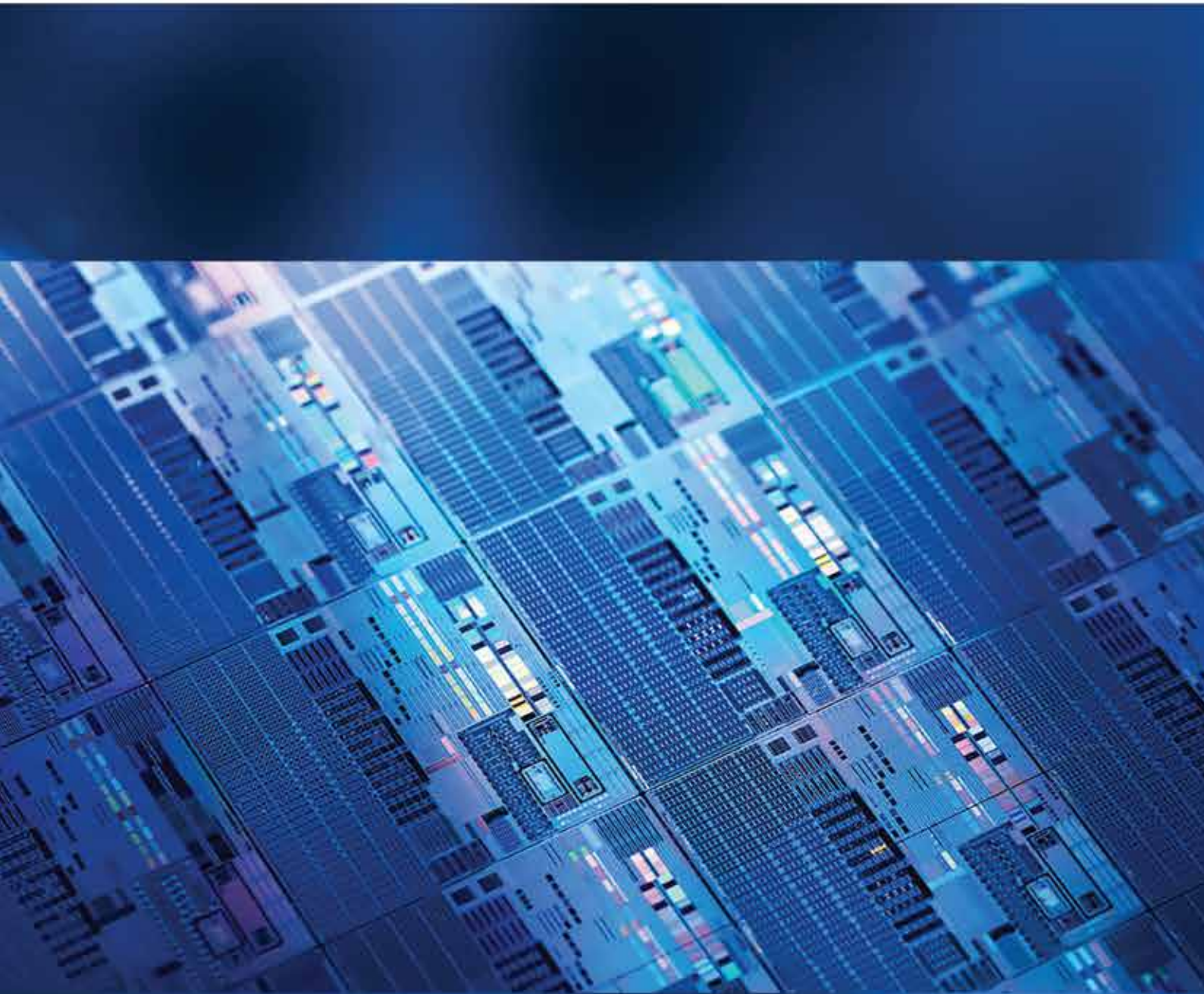

www.oricus-semicon.com
info@oricus-semicon.com