

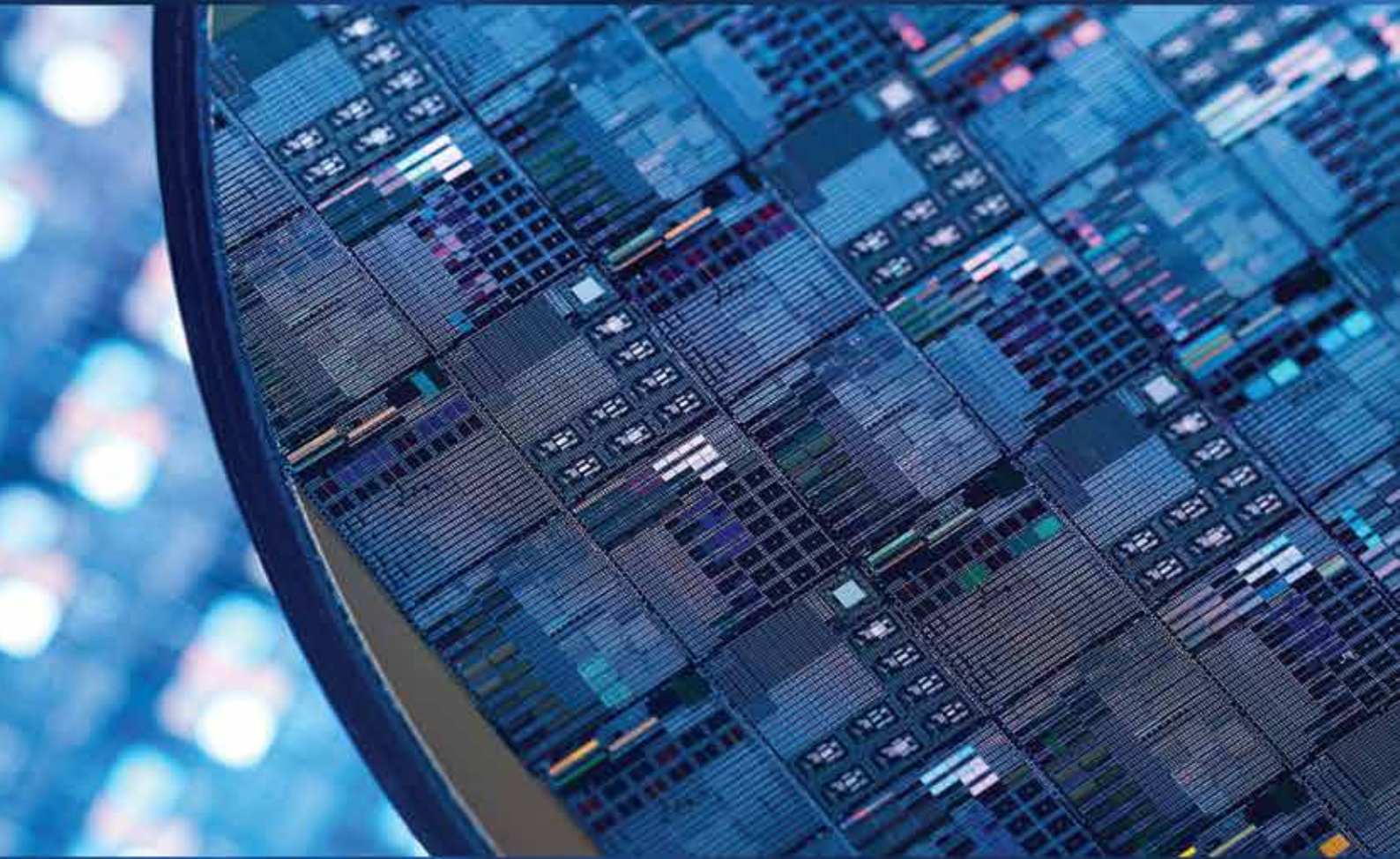

# Semiconductor Backend Tools Catalog



**2022**



# AT A GLANCE

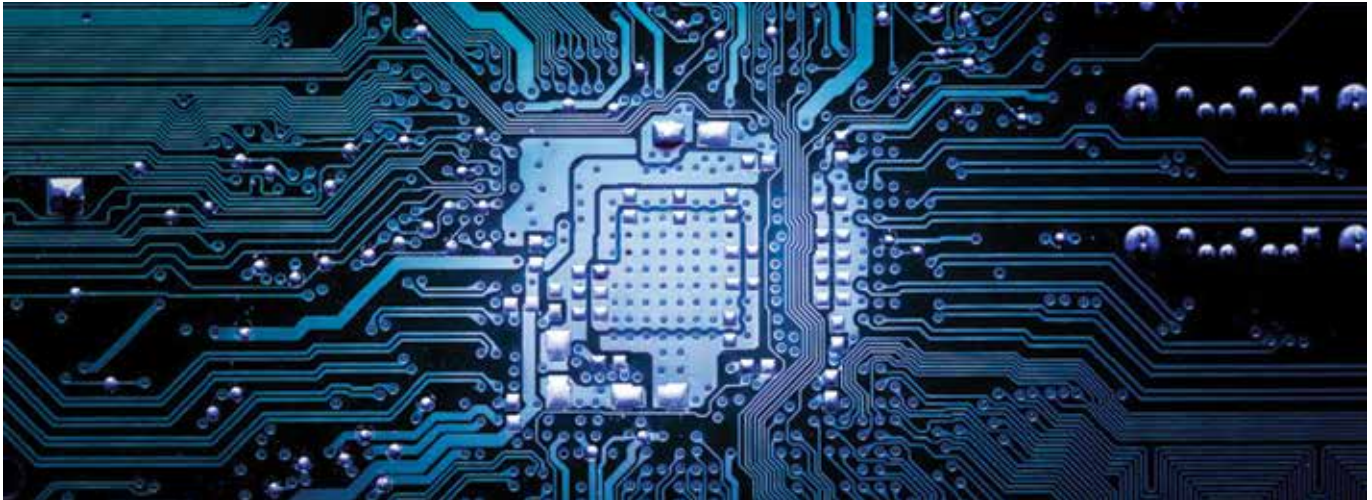

Oricus Semicon Solutions is an innovative Semiconductor Tools manufacturing company who, with almost 100 years of collective expertise, craft high tech bespoke tooling solutions for the global Semiconductor Assembly and Test industry.

From one-off customised products to large scale production, our R&D strength, precision manufacturing experience and problem-solving capabilities are impeccable. With a passion for engineering and customer oriented service, we deliver price competitive precision Semiconductor Tooling solutions to a global market with a local presence.

Oricus is made up of a global network of professionals with strong commitment and passion for our work. The company is managed and operated with a spirit of professionalism based on the foundation of integrity, equality and respect. We are determined, objective with a sense of ownership to deliver on our goals. We value our values, professionalism, passion, perseverance and our relentless pursuit to deliver value for our customers.



**Authenticity**



**Expertise**



**Professionalism**



**Perseverance**



**Passion**



**Community**



## Oriented to Customer's needs



We excel at creating specials – one of a kind pieces, with one of a kind craftsmanship combining with the latest in manufacturing technology to produce micro precision tooling. Oricus can Design and Manufacture either one-offs or high volume orders to your unique specifications, from High Temperature resistant tools for Power Devices to tools with complex geometries for 3D Advanced Packaging.

## Industry Leading Solutions

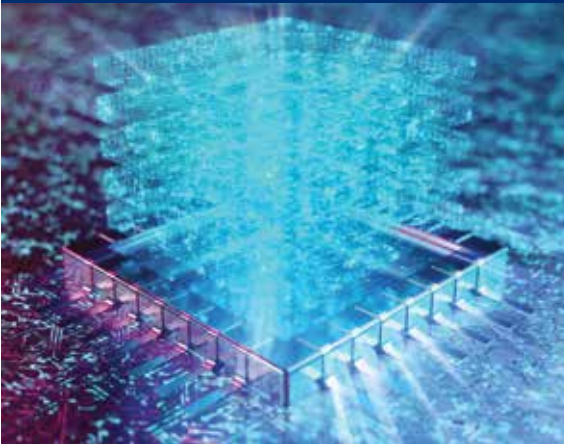

Our Technical Sales Consultants and R&D teams of seasoned Semiconductor Assembly and Test industry professionals will study your chip and package requirements and offer effective and competitive tooling solutions that will work right out of the box. Oricus has the solution to your tooling requirements. Leave it to us and you can focus on your key processes.

## Research and Development



R&D is the cornerstone of our commitment to deliver market leading tooling solutions. Our Material Science know-how, coupled with our Manufacturing Expertise and knowledge on the latest demands of Integrated Circuits Packaging allow us to offer tools that maximizes productivity and minimizes downtime.

# Die Attach

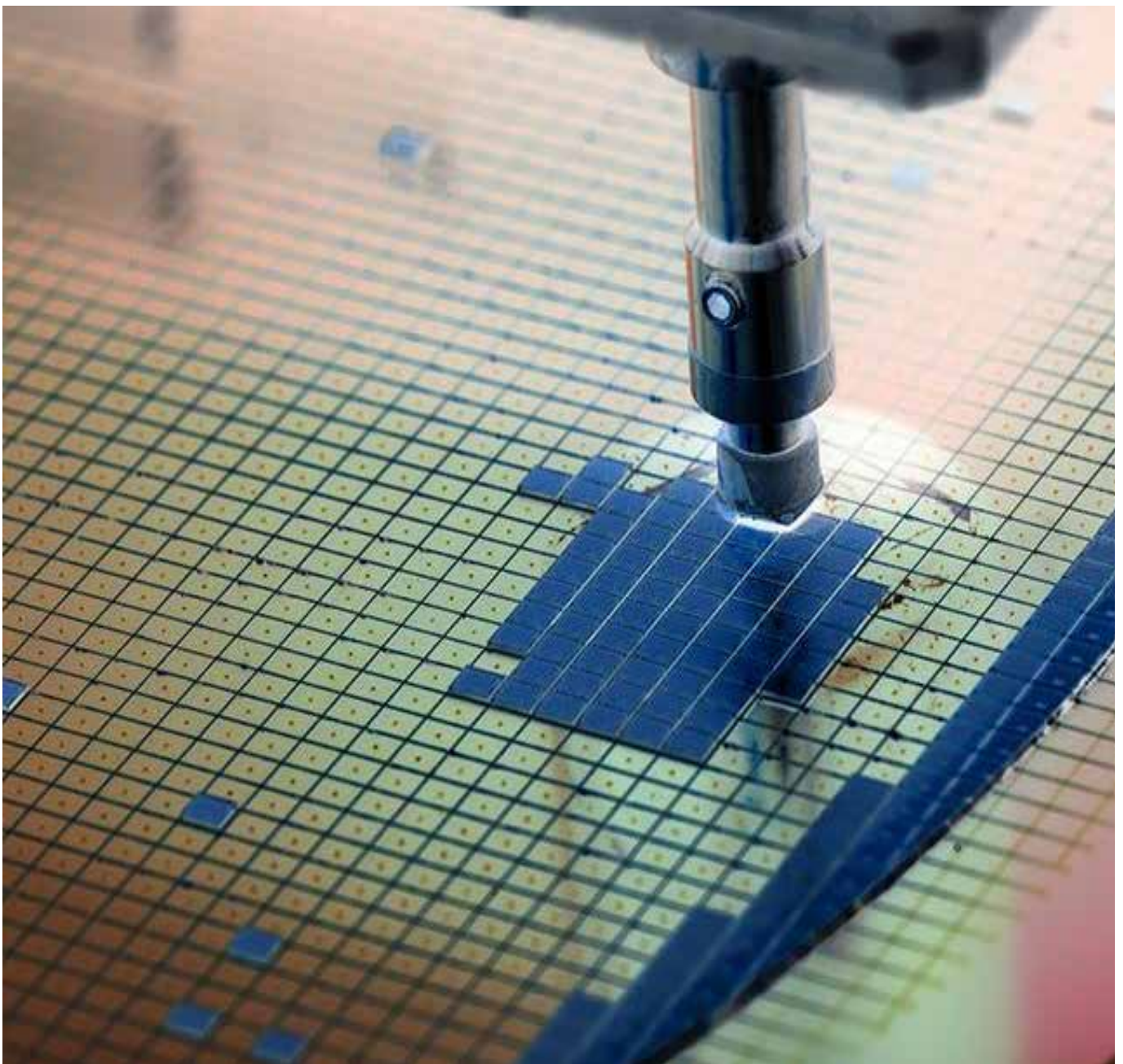

# Holding Systems



## Anvil Blocks

Anvil Blocks fully customizable to the pad size and pitch of your leadframe or substrate



## Comb Clamps

Comb Clamps are designed according to the layout of the leads or dam bar of your application.

## Part Numbers And Ordering

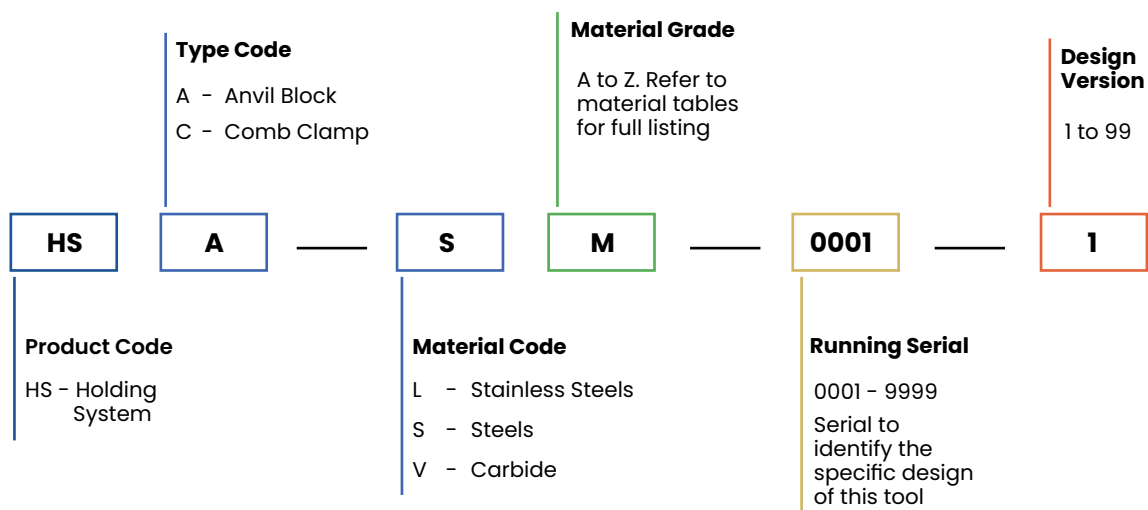

# Comb Clamps



Comb Clamps are used for clamping the leadframe or substrate firmly onto the Anvil Block during the Die Attach process. The function of the combs of each jaw for securing the leads or dam bar of the leadframe. The Comb Clamps are used in addition to vacuum suction on the Anvil Block for an added layer of security especially for critical packages.

Oricus manufactures Comb Clamps to fit a wide range of machines from OEMs such as Datacon, ESEC, ASM, Canon Bestem, Hitachi/Fasford, MRSI and more.

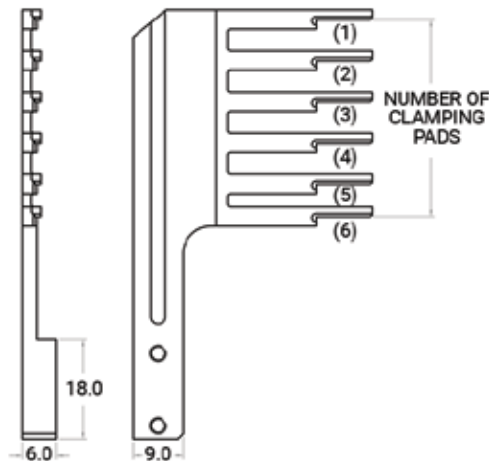

## Features

- Can be designed and adapted for use in a wide range of Die Attach machines.
- Available in various Superalloy, Stainless Steel and Tool Steel grades that are suitable for Cleanroom environments
- Clamping width of each comb jaw are machined to exacting tolerances to ensure the leadframe and substrate are held firmly onto the Anvil Block

## Benefits

- Our Comb Clamps are manufactured for a perfect fit to your specific application and equipment
- Plug-and-Play installation that reduces waste and minimizes set up time
- Allows for uniform clamping force to be applied on the lead fingers, dam bar or substrate to ensure stability throughout the entire Epoxy Dispensing and Die Attach process.

Part Number	Number of Clamping Pads
HSC-LE-0001-01	6
HSC-LE-0001-02	8
HSC-LE-0001-03	2
HSC-LE-0001-04	5
HSC-LE-0001-05	7
HSC-LE-0001-06	6



#### ESD Properties

Conductive <math>10^5 \Omega</math>

#### Applications

Standard Die Attach  
Flip Chip  
2.5D/3D  
Wafer Level Packaging  
Panel Level Packaging  
System in a Package

#### Comb Clamp Material

Superalloy  
Stainless Steels  
Tool Steels

#### Customization

Number of clamping pads  
Clamping pads profile



# MATERIALS

Oricus's extensive line of engineered materials specially developed and selected to offer optimal tooling performance for your specific Semiconductor Backend process. Our in-house materials are closely developed in partnership with Original Equipment Manufacturers with input from our customers. For externally procured materials, each material goes through a rigorous Quality Assurance and Performance Assessment programme before making it into our material list.

Oricus' in depth understanding and experience of materials allows us to formulate tooling solutions that work for you. As part of our value proposition, we study the conditions of your application and suggest the most appropriate material that meets your needs.

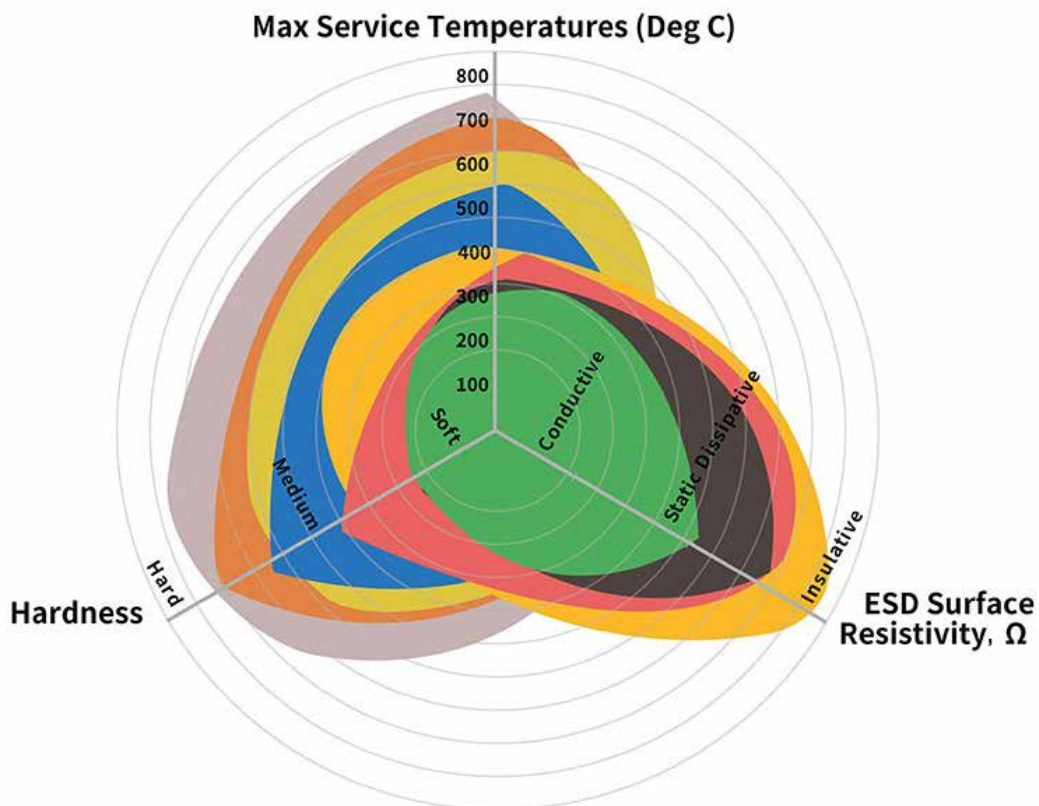

 Tungsten Carbide *WC Line*

 Superalloy *SA Line*

 Stainless Steel *SS Line*

 Tool Steel *TS Line*

 Non Ferrous Metals *NF Line*

 Performance Engineering Plastics *SP Line*

 Engineering Plastics *EP Line*

 Rubber *R Line*



<p><b>WC</b> LINE</p> <p><b>Tungsten Carbide</b></p> <p>High Wear &amp; High Temp Resistance</p> <p>Carbide, K15 Carbide, K30 Carbide, M30 Carbide K40 Carbide, MG30</p>	<p><b>SA</b> LINE</p> <p><b>Superalloy</b></p> <p>All-Round Superior Performance</p> <p>Haynes 25 (L605) Inconel Alloy 625 Inconel Alloy 718 Incoloy Alloy 925 Nitronic 50 Nitronic 60 Titanium Grade 2 Stellite 6 Stellite 31</p>	<p><b>SS</b> LINE</p> <p><b>Stainless Steel</b></p> <p>Balanced Properties</p> <p>15-5 PH 17-4PH SUS 430F SUS 420 SUS 440C SUS 316 SUS 301 SUS 304 SUS 303</p>	<p><b>TS</b> LINE</p> <p><b>Tool Steel</b></p> <p>High Strength</p> <p>CPM-10V SKD 11 SKH 51 Mirrax 40 ASP 23 Stavax XW 10 XW 42 Assab 718 - HH  HSS DF2 DF3 Ramax HH Rochling 2315</p>
<p><b>NF</b> LINE</p> <p><b>Non Ferrous Metals</b></p> <p>Special Applications</p> <p>Aluminium 7075 Aluminium 6061 Copper Brass Hovadur K350</p>	<p><b>SP</b> LINE</p> <p><b>Performance Engineering Plastics</b></p> <p>Advantageous Performance &amp; Value</p> <p>Torlon 4432 (PAI) Torlon 4301 (PAI) Torlon 5030 (PAI) Toriion 7130 (PAI) Vespel SCP5050 (P) Vespel SP 21 (PD) Vespel SP1 (PI) ESD Semitron 520 ESD Semitron 420 ESD Semitron 410C ESD Semitron 225</p>	<p><b>EP</b> LINE</p> <p><b>Engineering Plastics</b></p> <p>Economical And Versatile</p> <p>Acrylic/ Polycarbonate TECAFORM SD Delrin ESD Delrin White Delrin Black POM PEEK PEEK HT PEEK GF 30% PEEK CF 30%</p>	<p><b>R</b> LINE</p> <p><b>Rubber</b></p> <p>Geometric Flexibility ESD Protection</p> <p>NBR NBR (Soft) NBR (Hard) NBR (Coated) HPR HPR (Soft) HPR (Hard) UPR CR (ESD) CR</p>

# Contact Us

## United States

📍 40 Trolley Square, Wilmington, Delaware

✉ [us.sales@oricus-semicon.com](mailto:us.sales@oricus-semicon.com)

☎ +1 302 725 3188

## United Kingdom

📍 15 Charleville Circus, Flat 3 London

✉ [eu.sales@oricus-semicon.com](mailto:eu.sales@oricus-semicon.com)

☎ +44 330 128 9181

## Singapore

📍 2, 488 Sims Avenue, Singapore, 387560

✉ [sg.sales@oricus-semicon.com](mailto:sg.sales@oricus-semicon.com)

☎ +65 68649617

## Malaysia

📍 8, Jalan Damanlela, Pusat Bandar Damansara Wilayah Persekutuan, Kuala Lumpur

✉ [my.sales@oricus-semicon.com](mailto:my.sales@oricus-semicon.com)

☎ +60 154 600 0140

## Philippines

📍 I Light Industry and Science Park of the Philippines Cabuyao, Laguna

✉ [ph.sales@oricus-semicon.com](mailto:ph.sales@oricus-semicon.com)

☎ +63 2 8271 2168

## China

📍 Block D, Hangcheng Smart Security Science Park Shenzhen Guangdong

✉ [cn.sales@oricus-semicon.com](mailto:cn.sales@oricus-semicon.com)

☎ +86 400 842 7789

## Hong Kong

📍 #28-34, 88 Commercial Building Wing Lok St Sheung Wang

✉ [hk.sales@oricus-semicon.com](mailto:hk.sales@oricus-semicon.com)

☎ +852 3008 8283

## Taiwan

📍 7F, No.2-1, WhenHu Street Taipei, 11445

✉ [tw.sales@oricus-semicon.com](mailto:tw.sales@oricus-semicon.com)

☎ +886 2 7753 5371

## Korea

📍 27 Noksapyeong-daero 26ga-gil Seoul Seoul

✉ [kr.sales@oricus-semicon.com](mailto:kr.sales@oricus-semicon.com)

☎ +82 2 2023 6568



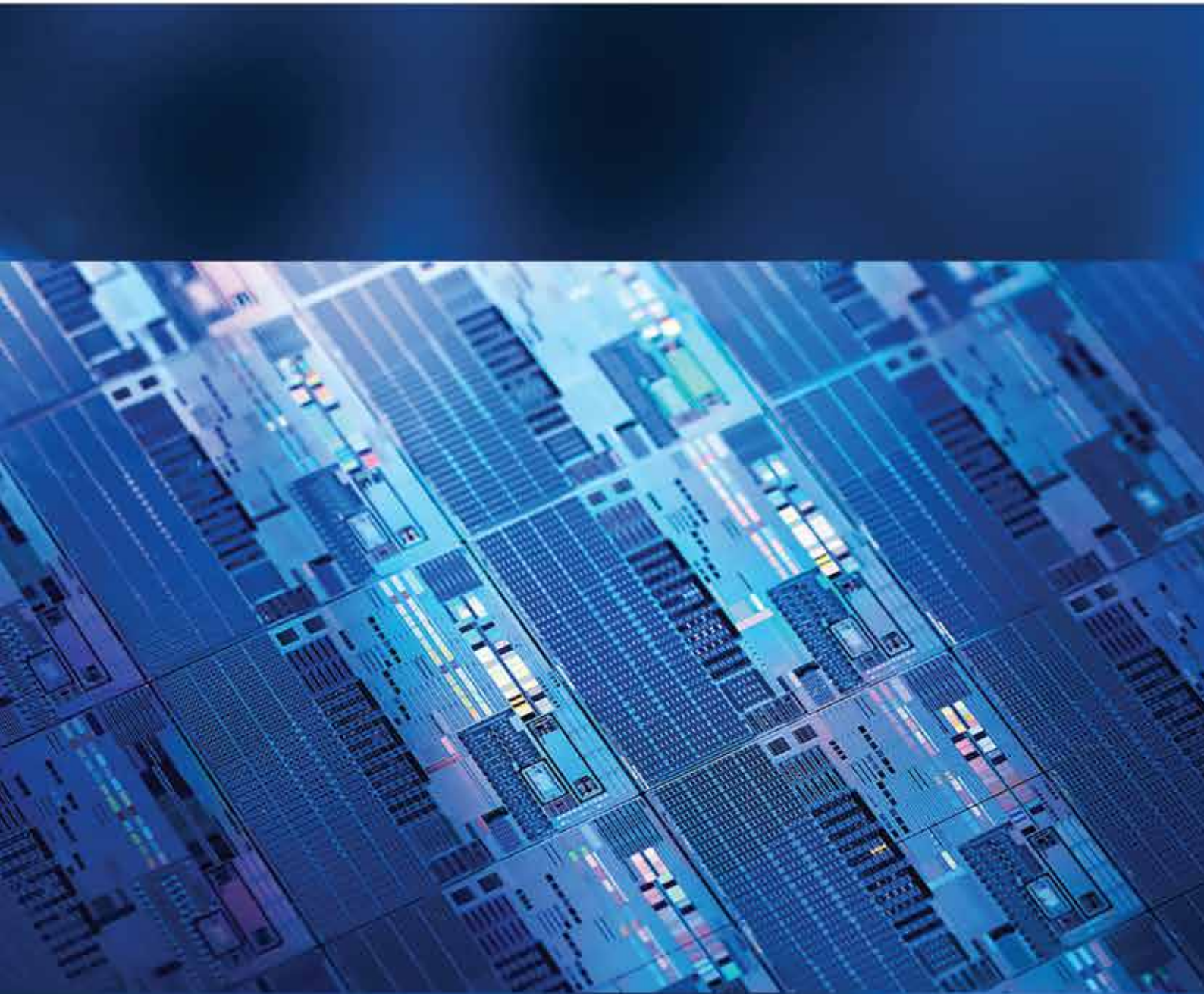

[www.oricus-semicon.com](http://www.oricus-semicon.com)  
[info@oricus-semicon.com](mailto:info@oricus-semicon.com)