

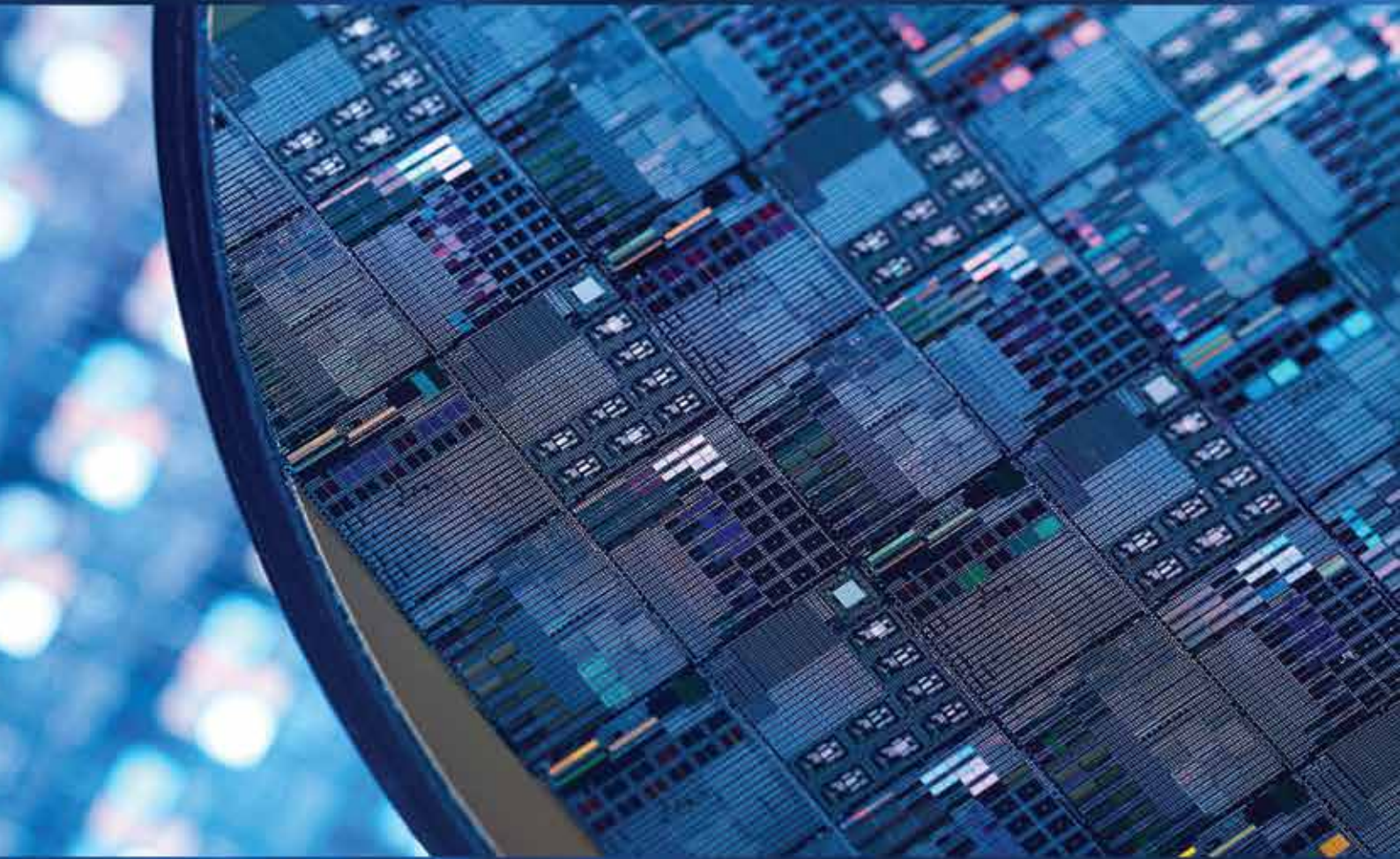

Semiconductor Backend Tools Catalog



2022



AT A GLANCE

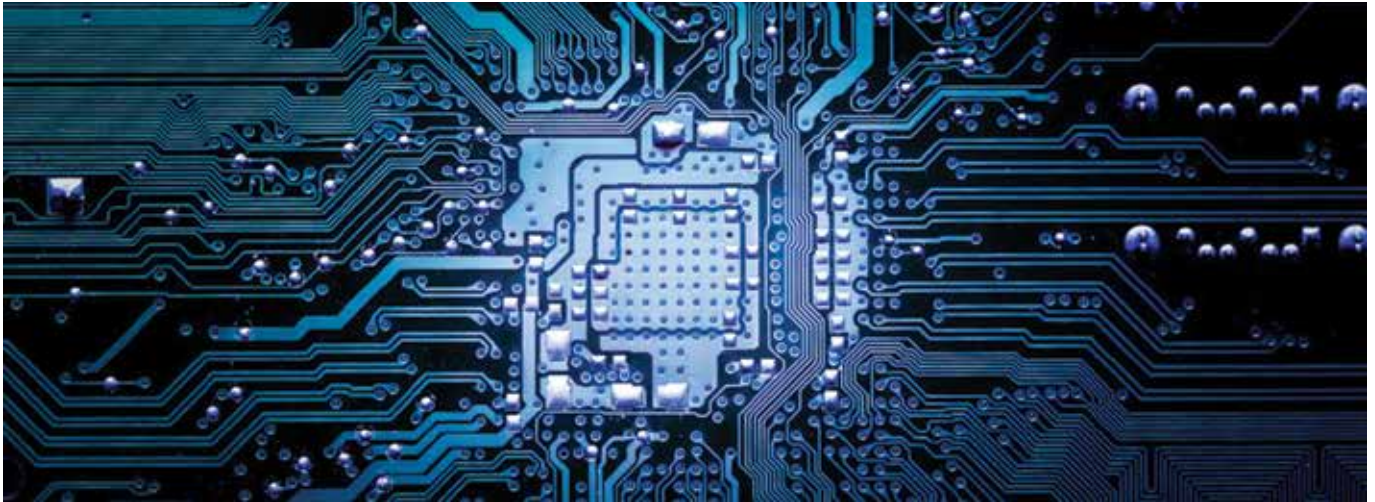

Oricus Semicon Solutions is an innovative Semiconductor Tools manufacturing company who, with almost 100 years of collective expertise, craft high tech bespoke tooling solutions for the global Semiconductor Assembly and Test industry.

From one-off customised products to large scale production, our R&D strength, precision manufacturing experience and problem-solving capabilities are impeccable. With a passion for engineering and customer oriented service, we deliver price competitive precision Semiconductor Tooling solutions to a global market with a local presence.

Oricus is made up of a global network of professionals with strong commitment and passion for our work. The company is managed and operated with a spirit of professionalism based on the foundation of integrity, equality and respect. We are determined, objective with a sense of ownership to deliver on our goals. We value our values, professionalism, passion, perseverance and our relentless pursuit to deliver value for our customers.



Authenticity



Expertise



Professionalism



Perseverance



Passion



Community

Oriented to Customer's needs



We excel at creating specials – one of a kind pieces, with one of a kind craftsmanship combining with the latest in manufacturing technology to produce micro precision tooling. Oricus can Design and Manufacture either one-offs or high volume orders to your unique specifications, from High Temperature resistant tools for Power Devices to tools with complex geometries for 3D Advanced Packaging.

Industry Leading Solutions

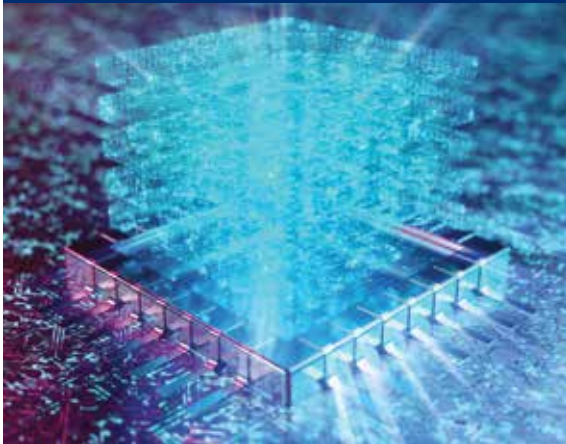

Our Technical Sales Consultants and R&D teams of seasoned Semiconductor Assembly and Test industry professionals will study your chip and package requirements and offer effective and competitive tooling solutions that will work right out of the box. Oricus has the solution to your tooling requirements. Leave it to us and you can focus on your key processes.

Research and Development



R&D is the cornerstone of our commitment to deliver market leading tooling solutions. Our Material Science know-how, coupled with our Manufacturing Expertise and knowledge on the latest demands of Integrated Circuits Packaging allow us to offer tools that maximizes productivity and minimizes downtime.

Die Attach

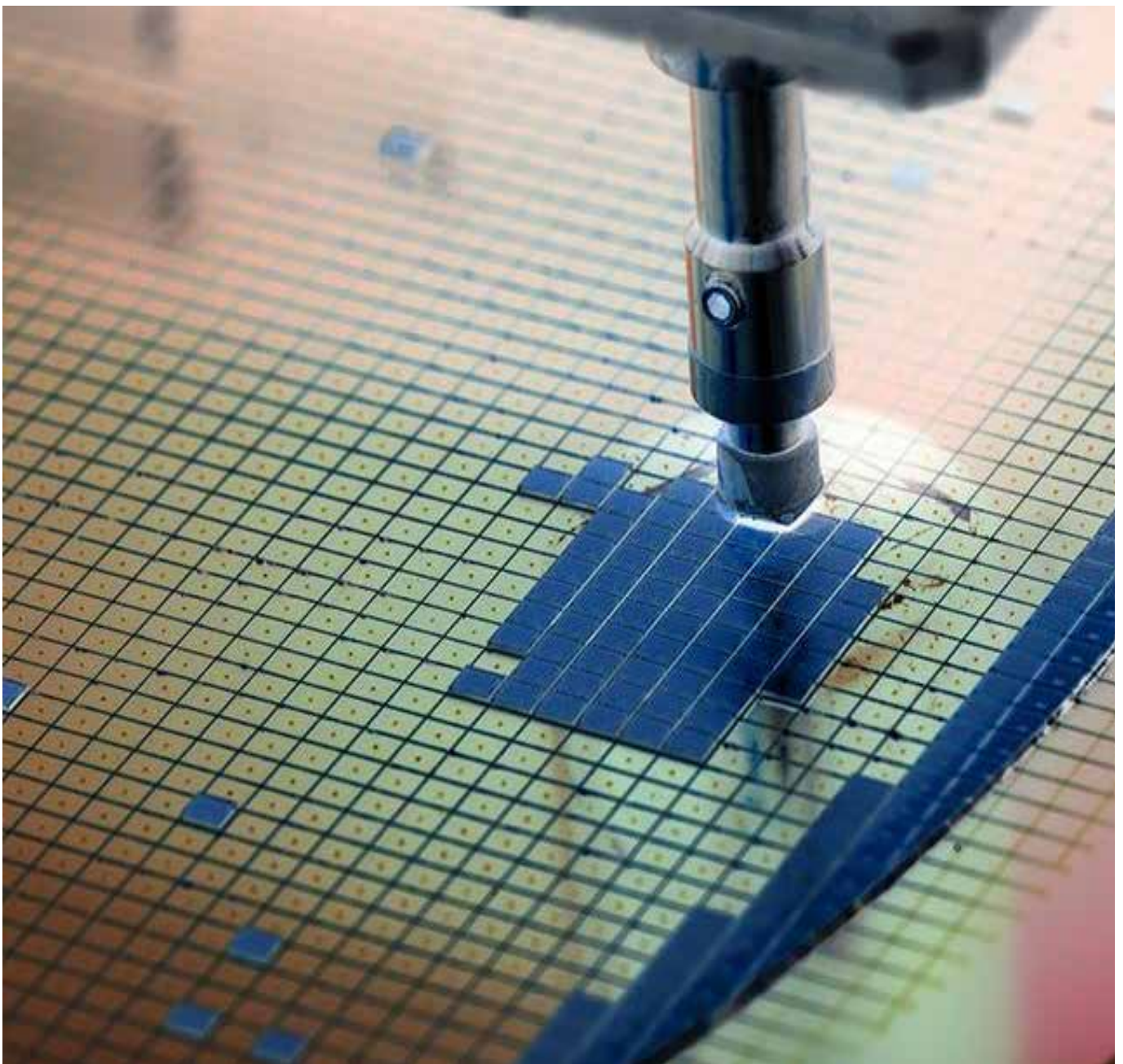

Pick-Up Tools



Engineering Plastics Tools

Polymeric tips made from POM, PI, PAI and PEI compounds. Economical, replaceable and lightweight, with mid resistance to temperature and wear.



Non Ferrous Tools

Non-Ferrous tools provide excellent thermal transfer and even heat distribution across the tip area with optimized levels of hardness and toughness.



Alloy / Special Alloy Tools

Tools made from Superalloys, Stainless Steel and Tool Steels. For applications that require high resistance of bond force, temperature and wear.



Hybrid Tools

Hybrids offer the performance of Tungsten Carbide while delivering the cost effectiveness of Alloy Tools. Delivers superior Cost to Performance advantages.



Carbide Tools

Toughest tools in our product lineup for the most demanding applications with the highest requirements of strength, temperature and wear resistance.

Part Numbers And Ordering

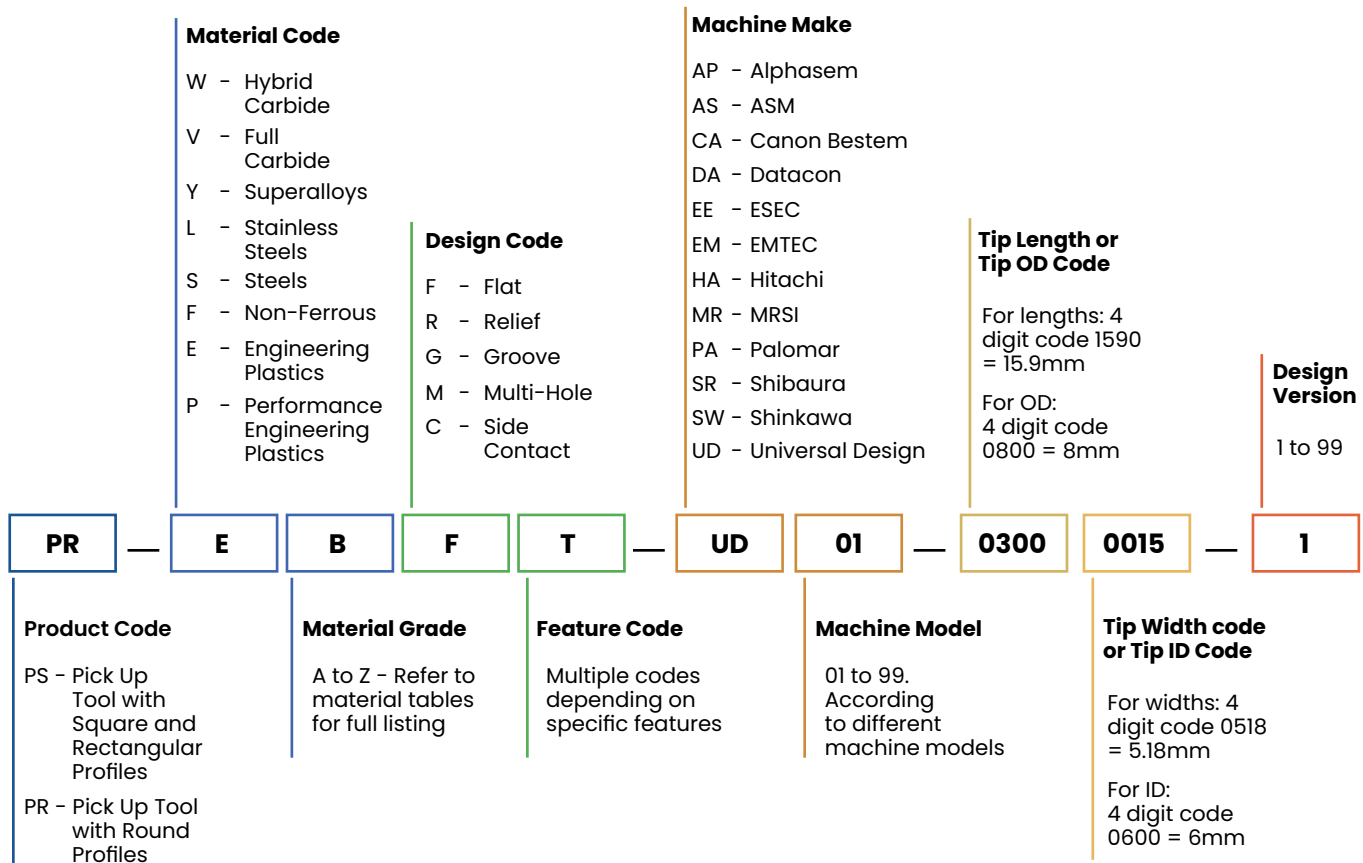

Non-Ferrous Tools



Groove Design

Non Ferrous Groove Tips are specifically designed for thin die applications with die thickness $\leq 0.1\text{mm}$ which are primarily used for bonded devices deployed in harsh environments.

Tip designs used for thin die applications require stable vacuum force while maximizing tip to die or device surface contact area.

Our Non-Ferrous Material Group comprises of materials that provide excellent thermal transfer and even heat distribution across the tip area with the appropriate levels of hardness and toughness for precision Die Attach to be performed.

Oricus manufactures a wide range of customized Non Ferrous Groove Tips with sizes and configurations designed to suit your application.

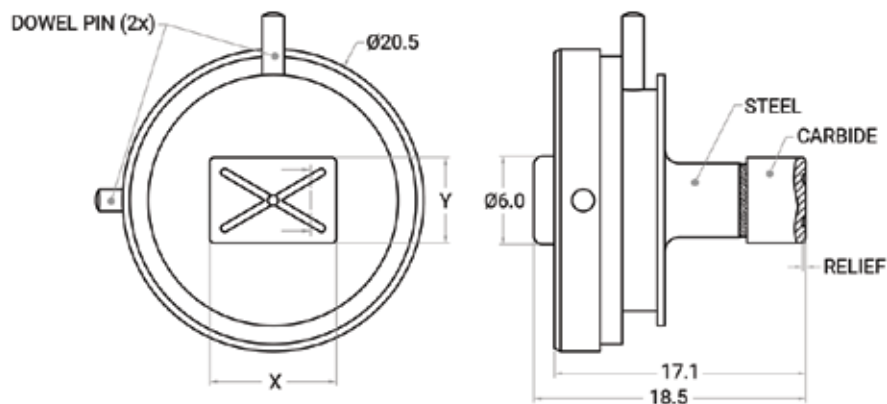

Features

- Offers a regulated suction programme to maximize suction force and tip to die contact
- Can be made in Round, Square, Rectangular and Custom outer profiles with different groove designs
- Groove options available between X profiles, Plus profiles, Asterisk profiles, Multi-Groove profiles or Scattered profiles
- Harder than Rubber/Engineering Plastics and softer than Steel Tips
- Higher wear and temperature resistance as compared to Rubber/Engineering Plastics and lower wear and temperature resistance as compared to Alloy Steel Tips

Benefits

- Minimizes the formation of voids on the substrate after the thin die has been placed or bonded
- Provides distributed vacuum forces to selected locations of dies or devices
- Compared to Flat Tip or Vacuum Relief designs, Groove Tips offers a balanced mix of surface contact and vacuum suction
- Excellent weight to performance ratio with superb heat distribution properties
- Less chipping issues as compared to Carbides as the Non Ferrous Tip wears off gradually

Part Number	X (mm)	Y (mm)
PS-FDGX-DA03-04000400-01	4.00	4.00
PS-FDGX-DA03-04500450-01	4.50	4.50
PS-FDGX-DA03-05000500-01	5.00	5.00
PS-FDGX-DA03-06000450-01	6.00	4.50
PS-FDGX-DA03-06000550-01	6.00	5.50
PS-FDGX-DA03-07500500-01	7.50	5.00
PS-FDGX-DA03-08000600-01	8.00	6.00
PS-FDGX-DA03-09000650-01	9.00	6.50
PS-FDGX-DA03-09000750-01	9.00	7.50
PS-FDGX-DA03-10001000-01	10.00	10.00



ESD Properties

Conductive < 10⁵ Ω

Applications

Standard Die Attach
Flip Chip
2.5D/3D
Wafer Level Packaging
Panel Level Packaging
System in a Package

Tool Material

Aluminium 7075
Aluminium 6061
Copper
Brass
Hovadur K350

Tip Profile Design

X profiles
Plus profiles
Asterisk profiles
Multi-Groove profiles
Scattered profiles

Outer Profiles

Round
Square
Rectangular
Custom

MATERIALS

Oricus's extensive line of engineered materials specially developed and selected to offer optimal tooling performance for your specific Semiconductor Backend process. Our in-house materials are closely developed in partnership with Original Equipment Manufacturers with input from our customers. For externally procured materials, each material goes through a rigorous Quality Assurance and Performance Assessment programme before making it into our material list.

Oricus' in depth understanding and experience of materials allows us to formulate tooling solutions that work for you. As part of our value proposition, we study the conditions of your application and suggest the most appropriate material that meets your needs.

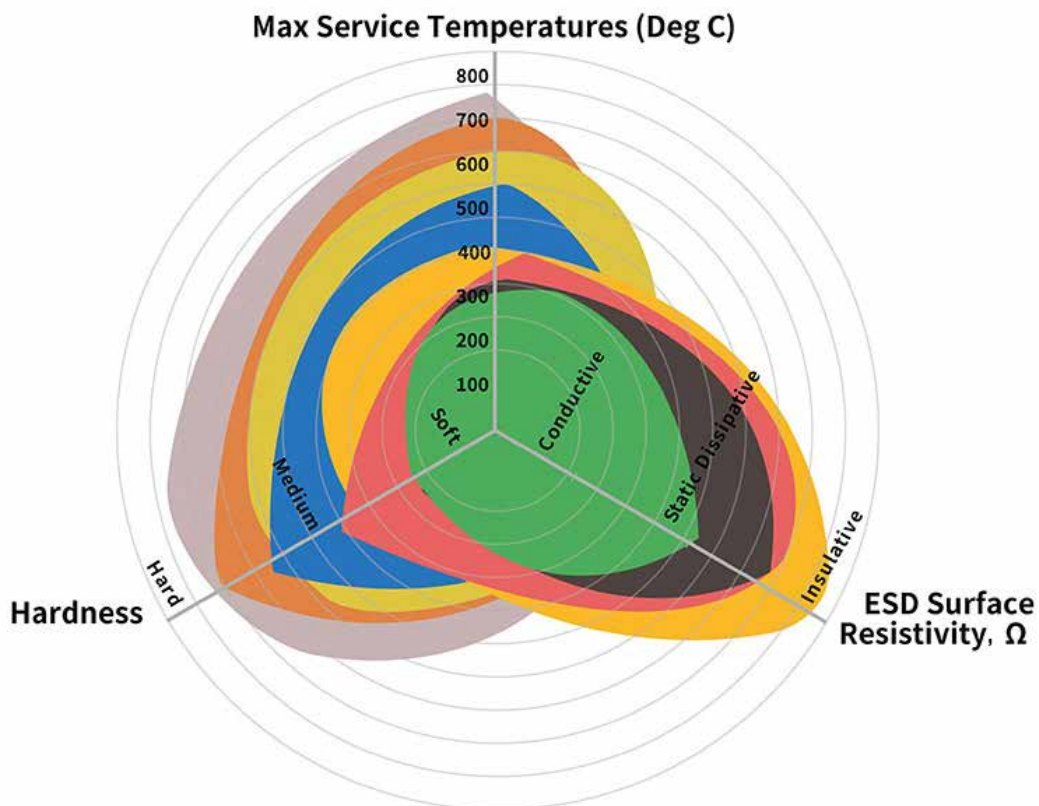

 Tungsten Carbide WC Line

 Non Ferrous Metals NF Line

 Superalloy SA Line

 Performance Engineering Plastics SP Line

 Stainless Steel SS Line

 Engineering Plastics EP Line

 Tool Steel TS Line

 Rubber R Line

<p>WC LINE</p> <p>Tungsten Carbide</p> <p>High Wear & High Temp Resistance</p> <ul style="list-style-type: none"> Carbide, K15 Carbide, K30 Carbide, M30 Carbide K40 Carbide, MG30 	<p>SA LINE</p> <p>Superalloy</p> <p>All-Round Superior Performance</p> <ul style="list-style-type: none"> Haynes 25 (L605) Inconel Alloy 625 Inconel Alloy 718 Incoloy Alloy 925 Nitronic 50 Nitronic 60 Titanium Grade 2 Stellite 6 Stellite 31 	<p>SS LINE</p> <p>Stainless Steel</p> <p>Balanced Properties</p> <ul style="list-style-type: none"> 15-5 PH 17-4PH SUS 430F SUS 420 SUS 440C SUS 316 SUS 301 SUS 304 SUS 303 	<p>TS LINE</p> <p>Tool Steel</p> <p>High Strength</p> <ul style="list-style-type: none"> CPM-10V SKD 11 SKH 51 Mirrax 40 ASP 23 Stavax XW 10 XW 42 Assab 718 - HH HSS DF2 DF3 Ramax HH Rochling 2315
<p>NF LINE</p> <p>Non Ferrous Metals</p> <p>Special Applications</p> <ul style="list-style-type: none"> Aluminium 7075 Aluminium 6061 Copper Brass Hovadur K350 	<p>SP LINE</p> <p>Performance Engineering Plastics</p> <p>Advantageous Performance & Value</p> <ul style="list-style-type: none"> Torlon 4432 (PAI) Torlon 4301 (PAI) Torlon 5030 (PAI) Torlon 7130 (PAI) Vespel SCP5050 (P) Vespel SP 21 (PD) Vespel SP1 (PI) ESD Semitron 520 ESD Semitron 420 ESD Semitron 410C ESD Semitron 225 	<p>EP LINE</p> <p>Engineering Plastics</p> <p>Economical And Versatile</p> <ul style="list-style-type: none"> Acrylic/ Polycarbonate TECAFORM SD Delrin ESD Delrin White Delrin Black POM PEEK PEEK HT PEEK GF 30% PEEK CF 30% 	<p>R LINE</p> <p>Rubber</p> <p>Geometric Flexibility ESD Protection</p> <ul style="list-style-type: none"> NBR NBR (Soft) NBR (Hard) NBR (Coated) HPR HPR (Soft) HPR (Hard) UPR CR (ESD) CR

Contact Us

United States

📍 40 Trolley Square, Wilmington, Delaware

✉ us.sales@oricus-semicon.com

☎ +1 302 725 3188

United Kingdom

📍 15 Charleville Circus, Flat 3 London

✉ eu.sales@oricus-semicon.com

☎ +44 330 128 9181

Singapore

📍 2, 488 Sims Avenue, Singapore, 387560

✉ sg.sales@oricus-semicon.com

☎ +65 68649617

Malaysia

📍 8, Jalan Damanlela, Pusat Bandar Damansara Wilayah Persekutuan, Kuala Lumpur

✉ my.sales@oricus-semicon.com

☎ +60 154 600 0140

Philippines

📍 I Light Industry and Science Park of the Philippines Cabuyao, Laguna

✉ ph.sales@oricus-semicon.com

☎ +63 2 8271 2168

China

📍 Block D, Hangcheng Smart Security Science Park Shenzhen Guangdong

✉ cn.sales@oricus-semicon.com

☎ +86 400 842 7789

Hong Kong

📍 #28-34, 88 Commercial Building Wing Lok St Sheung Wang

✉ hk.sales@oricus-semicon.com

☎ +852 3008 8283

Taiwan

📍 7F, No.2-1, WhenHu Street Taipei, 11445

✉ tw.sales@oricus-semicon.com

☎ +886 2 7753 5371

Korea

📍 27 Noksapyeong-daero 26ga-gil Seoul Seoul

✉ kr.sales@oricus-semicon.com

☎ +82 2 2023 6568



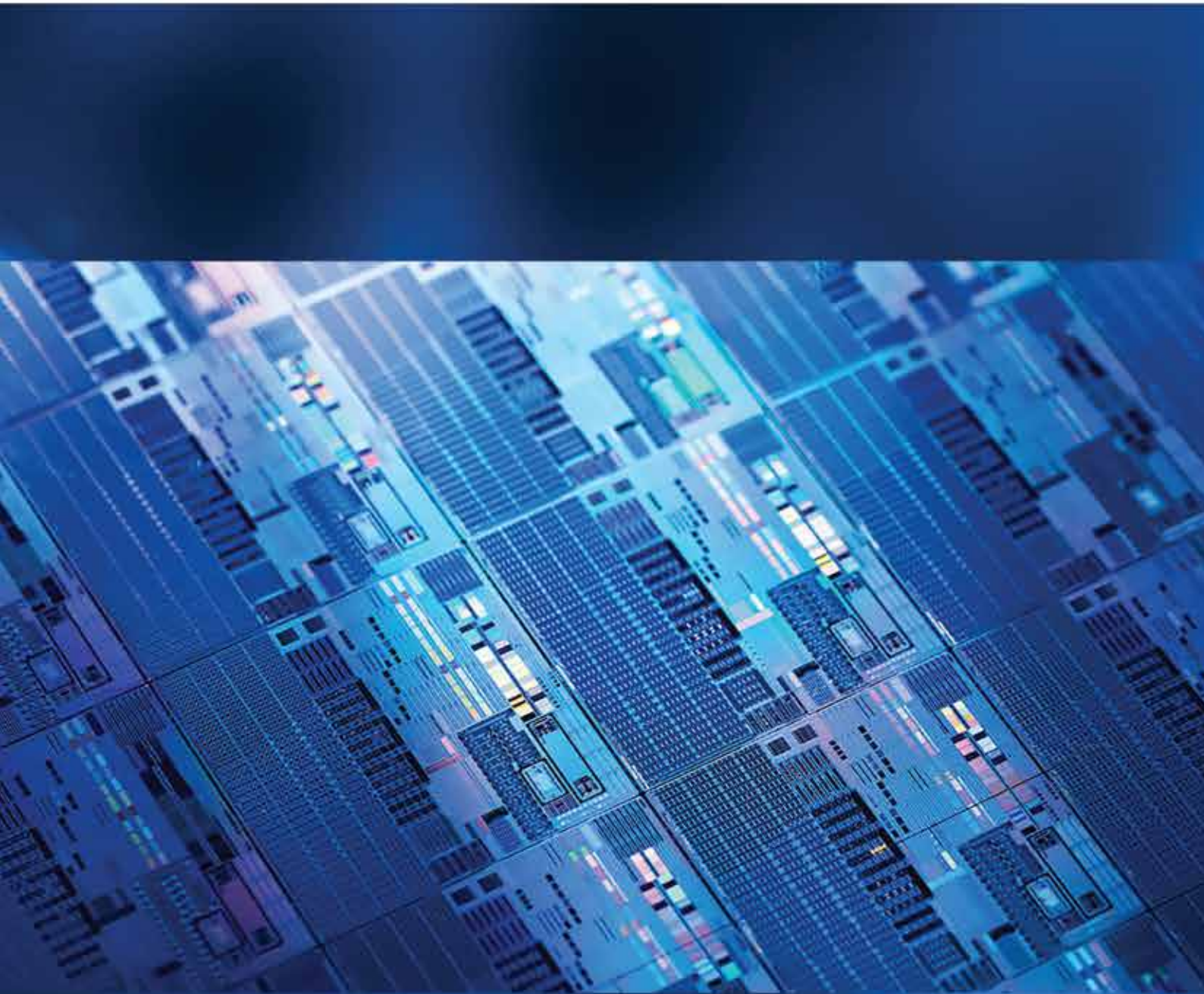

www.oricus-semicon.com
info@oricus-semicon.com