



Semiconductor Backend Tools Catalog



2022



AT A GLANCE

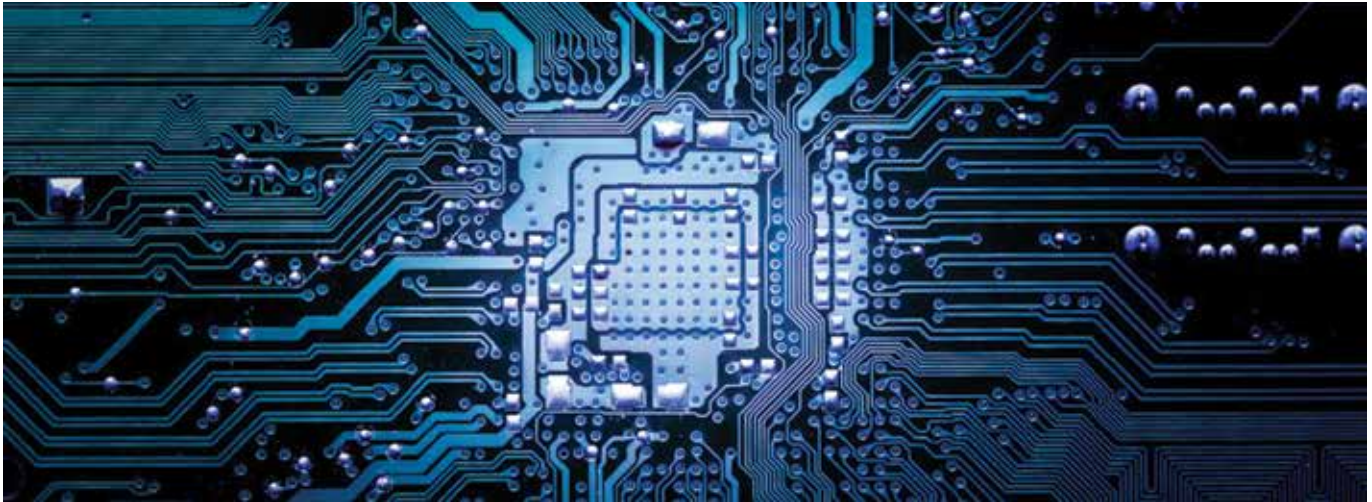

Oricus Semicon Solutions is an innovative Semiconductor Tools manufacturing company who, with almost 100 years of collective expertise, craft high tech bespoke tooling solutions for the global Semiconductor Assembly and Test industry.

From one-off customised products to large scale production, our R&D strength, precision manufacturing experience and problem-solving capabilities are impeccable. With a passion for engineering and customer oriented service, we deliver price competitive precision Semiconductor Tooling solutions to a global market with a local presence.

Oricus is made up of a global network of professionals with strong commitment and passion for our work. The company is managed and operated with a spirit of professionalism based on the foundation of integrity, equality and respect. We are determined, objective with a sense of ownership to deliver on our goals. We value our values, professionalism, passion, perseverance and our relentless pursuit to deliver value for our customers.



Authenticity



Expertise



Professionalism



Perseverance



Passion



Community

Oriented to Customer's needs



We excel at creating specials – one of a kind pieces, with one of a kind craftsmanship combining with the latest in manufacturing technology to produce micro precision tooling. Oricus can Design and Manufacture either one-offs or high volume orders to your unique specifications, from High Temperature resistant tools for Power Devices to tools with complex geometries for 3D Advanced Packaging.

Industry Leading Solutions

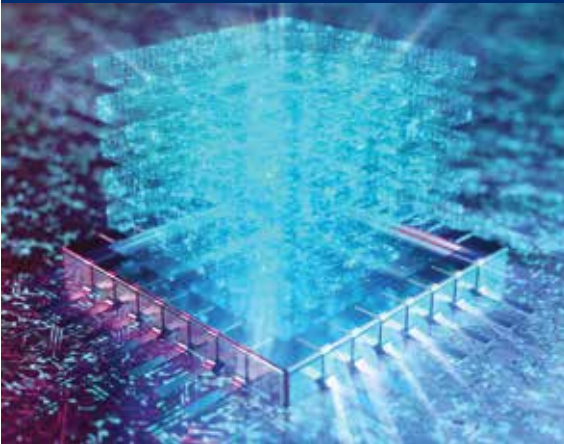

Our Technical Sales Consultants and R&D teams of seasoned Semiconductor Assembly and Test industry professionals will study your chip and package requirements and offer effective and competitive tooling solutions that will work right out of the box. Oricus has the solution to your tooling requirements. Leave it to us and you can focus on your key processes.

Research and Development



R&D is the cornerstone of our commitment to deliver market leading tooling solutions. Our Material Science know-how, coupled with our Manufacturing Expertise and knowledge on the latest demands of Integrated Circuits Packaging allow us to offer tools that maximizes productivity and minimizes downtime.

Die Attach

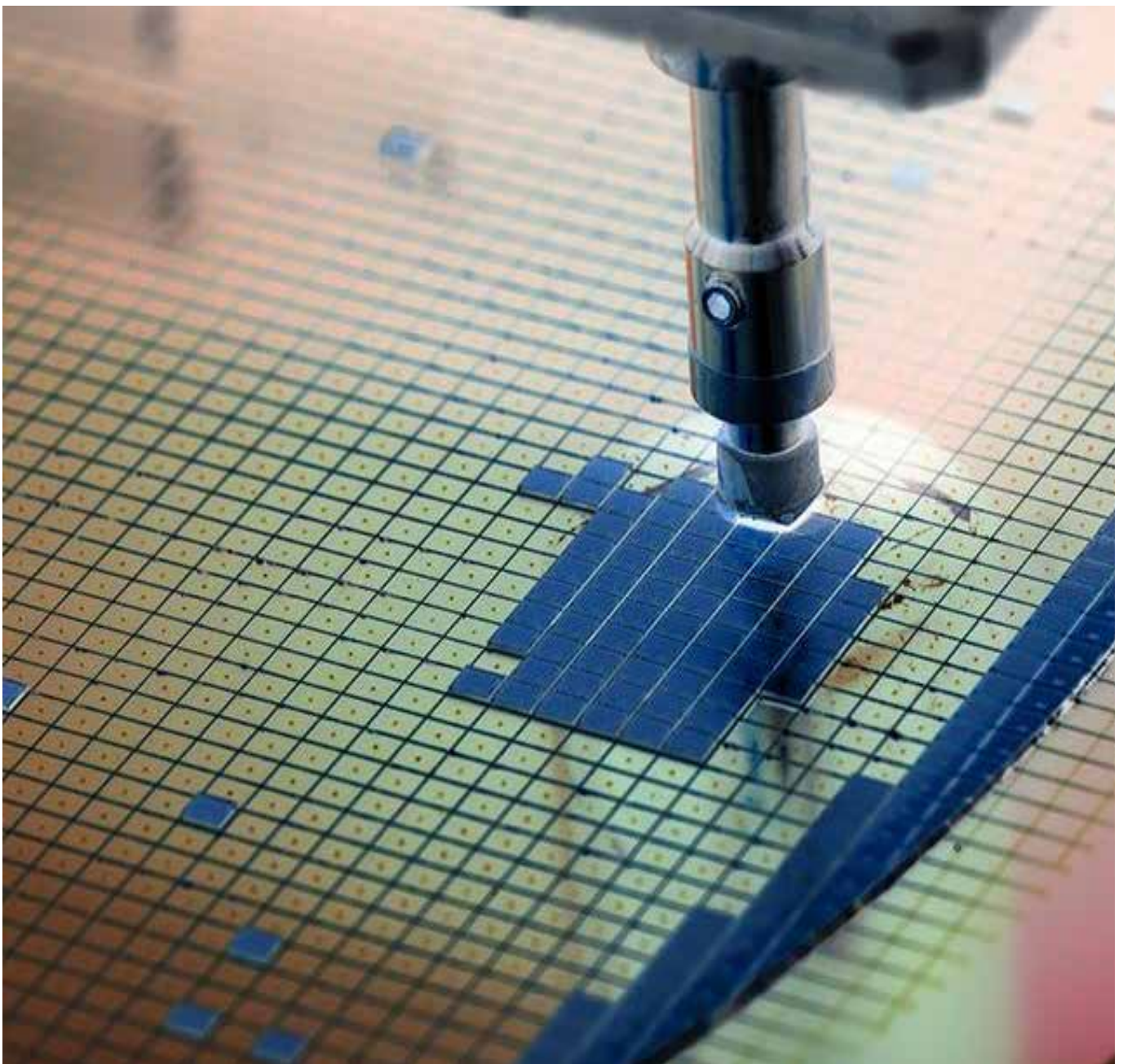

Rubber Tips



Flat Tips

Single central or offset vacuum hole drilled on a flat contact surface, controlled to stringent flatness tolerances.

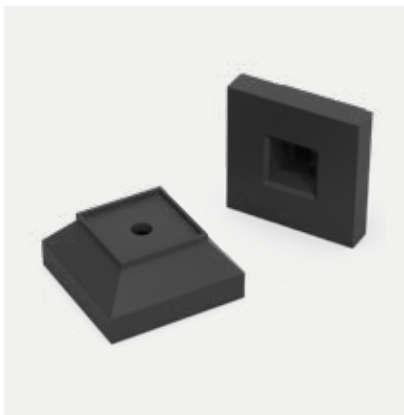

Vacuum Relief Tips

Designed to steer clear profiles or protrusions on your dies and devices, with a reservoir recess to enhance vacuum suction.



Groove Tips

Features central and branched vacuum grooves on the tip surface that enhances distributed suction force coverage.



Matrix Tips

Full Tungsten Carbide Tips with Vacuum holes drilled in a distributed matrix layout. Offers superior surface contact and stable suction pressure.

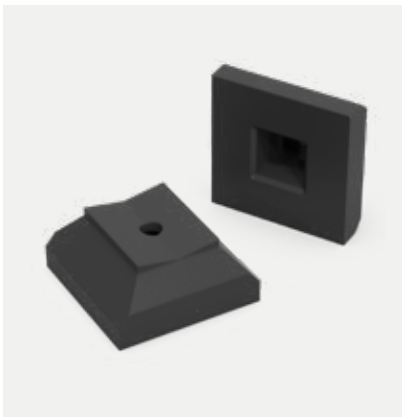

Side Contact Tips

Engineered with precisely calculated tapered contact angles to grip specific edges of your die to avoid contact of critical areas.

Part Numbers And Ordering

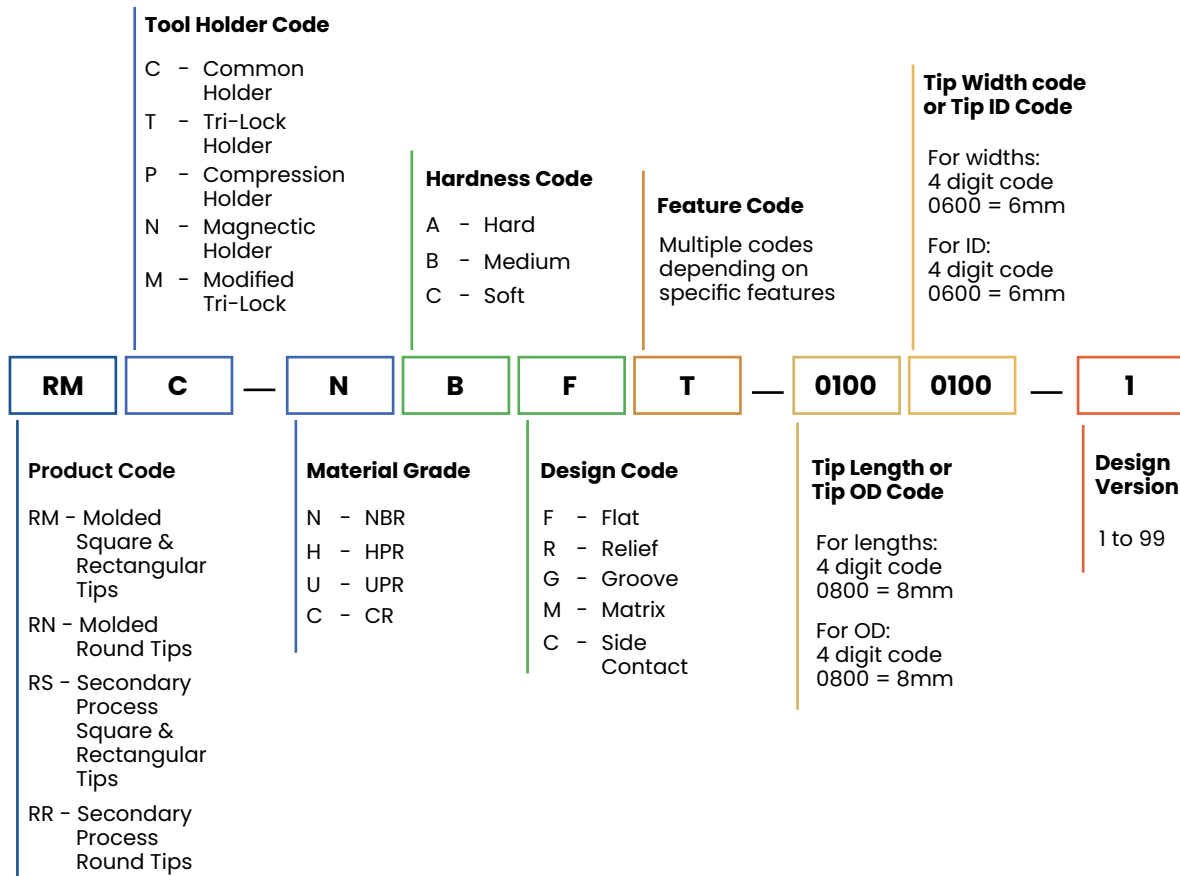

Side Contact

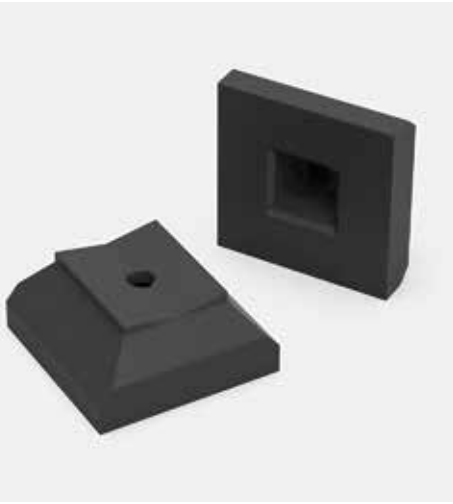

Rubber Side Contact Tips are suitable for use in applications where tip contact to the surface of the die should be limited or avoided. For these applications, we do not recommend the use of surface contact tip designs in order to safeguard the critical features on the die surface.

The design of our Side Contact Tips features tapered contact angles to contact the selected edges of the die. Our innovative tip geometries ensure the stability and performance for such critical applications during the Pick and Place process.

Oricus manufactures a wide range of customized Rubber Side Contact Tips with angle configurations designed and manufactured to fit your die and application requirements. Standard angle configurations of 5°, 10°, 15° or 20° are available. We are also able to produce customized angles and application specific geometries to your requirements.

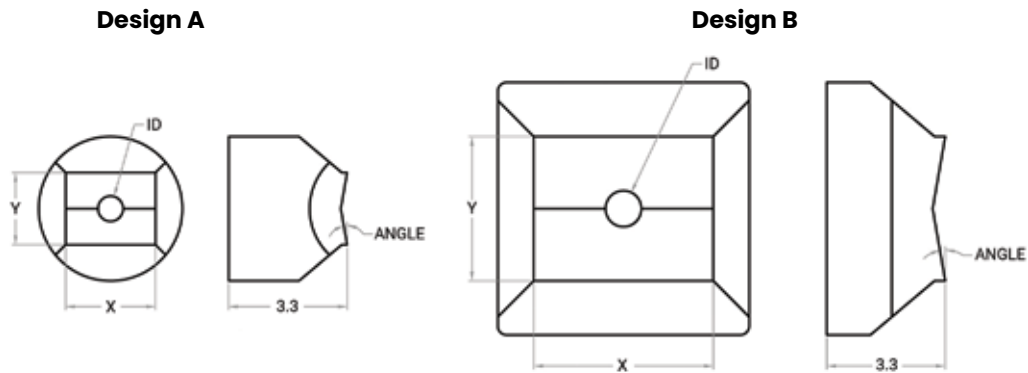

Features

- Minimize surface contact between tip and the die or device
- Suitable for use with our Tri-Lock, Compression and Magnetic Holders
- Available in NBR, HPR, UPR and CR Rubber Materials
- 50-90 Shore A Hardness levels to cater to wide range of applications
- E6-E9 Static Dissipative properties to ensure proper Electrostatic Discharge
- Can be made in Round, Square, Rectangular and Custom outer profiles

Benefits

- Able to leave critical features of the die surfaces untouched during the Pick and Place process
- Rubber Side Contact Tips allows for more controlled contact forces with lower risk of damage to delicate dies
- Eliminates potential issues resulting from die rotation which is apparent in surface contact tip design types
- Pick-and-Place impact and bond forces are absorbed by the soft and accommodating nature of our Rubber Flat Tips to ensure that the die or device is not damaged in any way

Part Number	X (mm)	Y (mm)	ID (mm)	ANGLE	Design
RSC-NBCT-01350125-1	1.35	1.25	0.6	10°	A
RSC-NBCT-01500100-1	1.50	1.00	0.4	5°	A
RSC-NBCT-01500100-2	1.50	1.00	0.4	10°	A
RSC-NBCT-01800130-1	1.80	1.30	0.6	5°	A
RSC-NBCT-02000140-1	2.00	1.40	0.6	5°	A
RSC-NBCT-02000150-1	2.00	1.50	0.4	10°	A
RSC-NBCT-02500160-1	2.50	1.60	0.6	5°	A
RSC-NBCT-02850285-1	2.85	2.85	0.7	5°	A
RSC-NBCT-03000150-1	3.00	1.50	0.4	5°	A
RSC-NBCT-03000300-1	3.00	3.00	1.0	5°	B
RSC-NBCT-03500350-1	3.50	3.50	1.0	5°	B
RSC-NBCT-03500350-2	3.50	3.50	1.0	10°	B
RSC-NBCT-04000275-1	4.00	3.75	1.0	10°	B
RSC-NBCT-04500350-1	4.50	3.50	1.0	5°	B
RSC-NBCT-04500350-2	4.50	3.50	1.0	10°	B
RSC-NBCT-05000250-1	5.00	2.50	1.0	10°	B
RSC-NBCT-05000450-1	5.00	4.50	1.0	5°	B
RSC-NBCT-05500350-1	5.50	3.50	1.0	5°	B
RSC-NBCT-06000400-1	6.00	4.00	1.0	10°	B
RSC-NBCT-06500400-1	6.50	4.00	1.0	10°	B

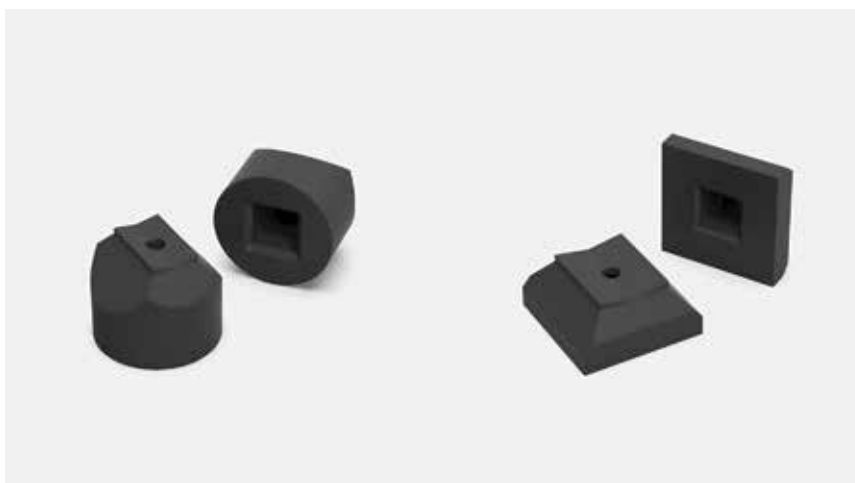

Colors

- White
- Black

ESD Properties

Static Dissipative $\geq 10^5$ to $10^9 \Omega$

Applications

- Standard Die Attach
- Flip Chip
- 2.5D/3D
- Wafer Level Packaging
- Panel Level Packaging
- System in a Package

Tip Material

- NBR
- HPR
- UPR
- CR

Tip Angle Profiles

- 5°
- 10°
- 15°
- 20°
- Custom

Outer Profiles

- Square
- Rectangular
- Custom

Rubber Holder Compatibility

- Common Holders
- Tri-Lock Holders
- Compression Holders
- Magnetic Holders
- Spring-Loaded Holders

MATERIALS

Oricus's extensive line of engineered materials specially developed and selected to offer optimal tooling performance for your specific Semiconductor Backend process. Our in-house materials are closely developed in partnership with Original Equipment Manufacturers with input from our customers. For externally procured materials, each material goes through a rigorous Quality Assurance and Performance Assessment programme before making it into our material list.

Oricus' in depth understanding and experience of materials allows us to formulate tooling solutions that work for you. As part of our value proposition, we study the conditions of your application and suggest the most appropriate material that meets your needs.

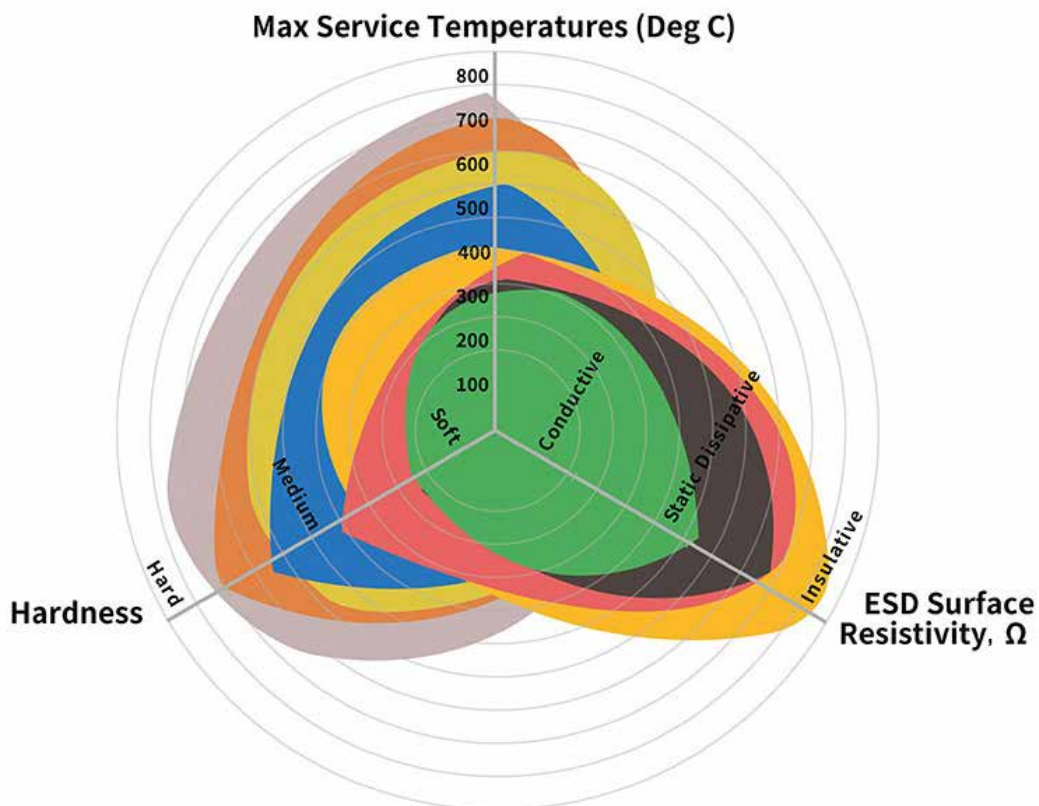

 Tungsten Carbide *WC Line*

 Superalloy *SA Line*

 Stainless Steel *SS Line*

 Tool Steel *TS Line*

 Non Ferrous Metals *NF Line*

 Performance Engineering Plastics *SP Line*

 Engineering Plastics *EP Line*

 Rubber *R Line*

<p>WC LINE</p> <p>Tungsten Carbide</p> <p>High Wear & High Temp Resistance</p> <p>Carbide, K15 Carbide, K30 Carbide, M30 Carbide K40 Carbide, MG30</p>	<p>SA LINE</p> <p>Superalloy</p> <p>All-Round Superior Performance</p> <p>Haynes 25 (L605) Inconel Alloy 625 Inconel Alloy 718 Incoloy Alloy 925 Nitronic 50 Nitronic 60 Titanium Grade 2 Stellite 6 Stellite 31</p>	<p>SS LINE</p> <p>Stainless Steel</p> <p>Balanced Properties</p> <p>15-5 PH 17-4PH SUS 430F SUS 420 SUS 440C SUS 316 SUS 301 SUS 304 SUS 303</p>	<p>TS LINE</p> <p>Tool Steel</p> <p>High Strength</p> <p>CPM-10V SKD 11 SKH 51 Mirrax 40 ASP 23 Stavax XW 10 XW 42 Assab 718 - HH HSS DF2 DF3 Ramax HH Rochling 2315</p>
<p>NF LINE</p> <p>Non Ferrous Metals</p> <p>Special Applications</p> <p>Aluminium 7075 Aluminium 6061 Copper Brass Hovadur K350</p>	<p>SP LINE</p> <p>Performance Engineering Plastics</p> <p>Advantageous Performance & Value</p> <p>Torlon 4432 (PAI) Torlon 4301 (PAI) Torlon 5030 (PAI) Toriion 7130 (PAI) Vespel SCP5050 (P) Vespel SP 21 (PD) Vespel SP1 (PI) ESD Semitron 520 ESD Semitron 420 ESD Semitron 410C ESD Semitron 225</p>	<p>EP LINE</p> <p>Engineering Plastics</p> <p>Economical And Versatile</p> <p>Acrylic/ Polycarbonate TECAFORM SD Delrin ESD Delrin White Delrin Black POM PEEK PEEK HT PEEK GF 30% PEEK CF 30%</p>	<p>R LINE</p> <p>Rubber</p> <p>Geometric Flexibility ESD Protection</p> <p>NBR NBR (Soft) NBR (Hard) NBR (Coated) HPR HPR (Soft) HPR (Hard) UPR CR (ESD) CR</p>

Contact Us

United States

📍 40 Trolley Square, Wilmington, Delaware

✉ us.sales@oricus-semicon.com

☎ +1 302 725 3188

United Kingdom

📍 15 Charleville Circus, Flat 3 London

✉ eu.sales@oricus-semicon.com

☎ +44 330 128 9181

Singapore

📍 2, 488 Sims Avenue, Singapore, 387560

✉ sg.sales@oricus-semicon.com

☎ +65 68649617

Malaysia

📍 8, Jalan Damanlela, Pusat Bandar Damansara Wilayah Persekutuan, Kuala Lumpur

✉ my.sales@oricus-semicon.com

☎ +60 154 600 0140

Philippines

📍 I Light Industry and Science Park of the Philippines Cabuyao, Laguna

✉ ph.sales@oricus-semicon.com

☎ +63 2 8271 2168

China

📍 Block D, Hangcheng Smart Security Science Park Shenzhen Guangdong

✉ cn.sales@oricus-semicon.com

☎ +86 400 842 7789

Hong Kong

📍 #28-34, 88 Commercial Building Wing Lok St Sheung Wang

✉ hk.sales@oricus-semicon.com

☎ +852 3008 8283

Taiwan

📍 7F, No.2-1, WhenHu Street Taipei, 11445

✉ tw.sales@oricus-semicon.com

☎ +886 2 7753 5371

Korea

📍 27 Noksapyeong-daero 26ga-gil Seoul Seoul

✉ kr.sales@oricus-semicon.com

☎ +82 2 2023 6568



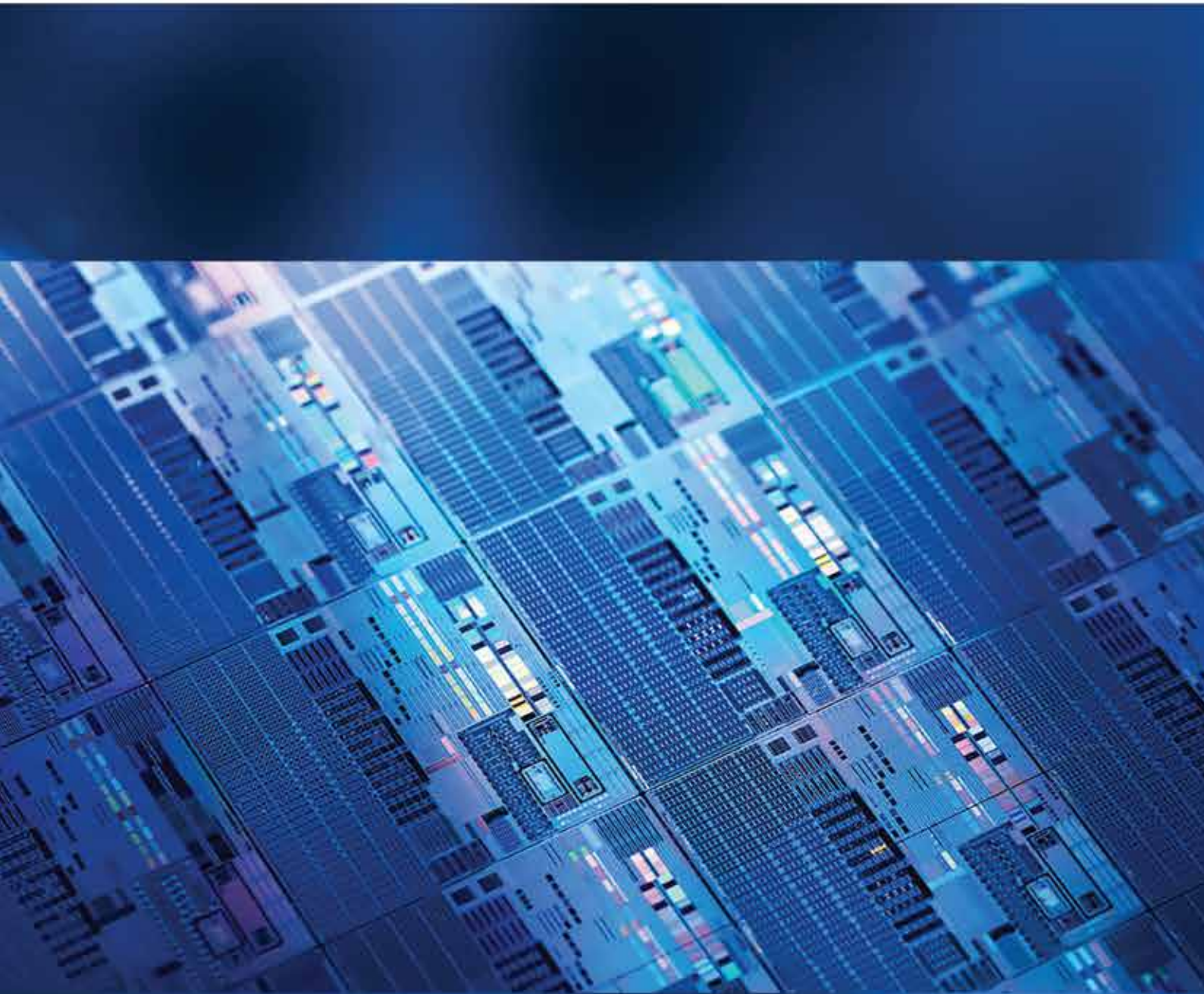

www.oricus-semicon.com
info@oricus-semicon.com